

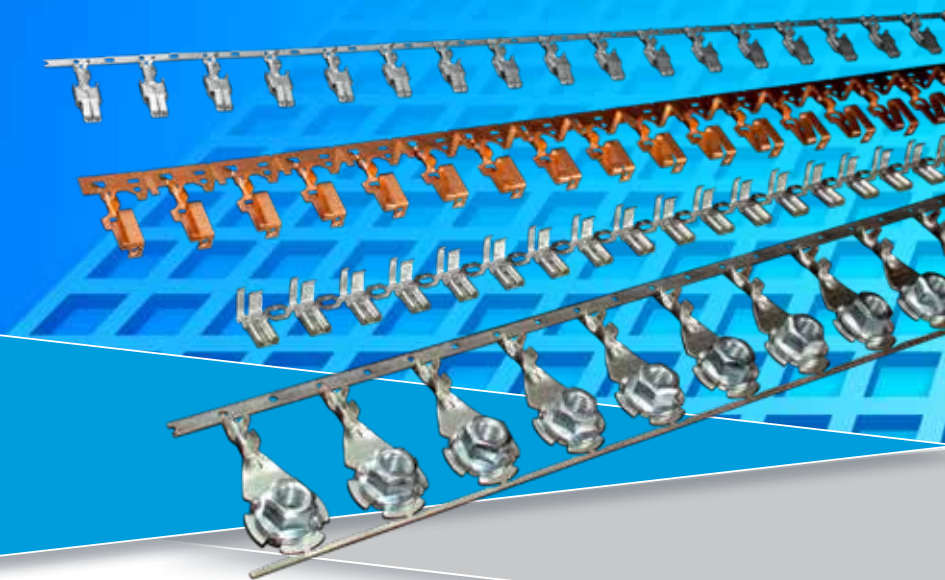

THE SOURCE OF YOUR  
CONNECTION

# LOSE UND IN BANDFORM CRIMPKONTAKTE



CRIMP CONTACTS  
LOOSE AND IN BANDOLIER FORM



## UNSERE PRODUKTE

- Steckverbindersysteme mit Schneidklemm-, Crimp- oder Lötanschluss
- Crimpkontakte
- Kabelschuhe
- Lötfreie Verbinder
- Kundenspezifische Sonderentwicklungen
- Verarbeitungssysteme für alle STOCKO-Produkte: Handzangen, Halb- und Vollautomaten

## UNSERE MÄRKTE

- Haustechnik
- Heizungstechnik
- Automotive
- Industrie
- Vertriebspartner

## WERKE

- Wuppertal / Deutschland
- Hellenthal / Deutschland
- Andlau / Frankreich
- Shanghai / China

## GESICHERTE QUALITÄT ZERTIFIZIERTE INTEGRIERTE MANAGEMENTSYSTEME

- |                               |                              |                                |
|-------------------------------|------------------------------|--------------------------------|
| ▪ Zertifiziert nach           |                              |                                |
| ISO 9001                      | ISO 9001                     | ISO 9001                       |
| ISO 14001                     | ISO 14001                    |                                |
| ISO 50001                     | ISO 50001                    |                                |
| IATF 16949                    | IATF 16949                   |                                |
| STOCKO CONTACT<br>Deutschland | STOCKO CONTACT<br>Frankreich | STOCKO CONTACT<br>China (Malu) |

## GRÜNDUNG

- 1901 in Wuppertal

## MITARBEITER WELTWEIT

- 750

## OUR PRODUCTS

- Multi-way connector systems with terminations for insulation displacement, crimping or soldering
- Crimp contacts
- Cable lugs/ring terminals
- Solderless terminals
- Customers' special products
- Terminating systems for all STOCKO products: Hand tools, semi- and fully automated machines

## OUR MARKETS

- Home Appliance
- HVAC
- Automotive
- Industry
- Sales partner

## FACTORIES

- Wuppertal / Germany
- Hellenthal / Germany
- Andlau / France
- Shanghai / China

## ASSURED QUALITY CERTIFIED INTEGRATED MANAGEMENT SYSTEMS

- |                           |                          |                                |
|---------------------------|--------------------------|--------------------------------|
| ▪ Certified according to  |                          |                                |
| ISO 9001                  | ISO 9001                 | ISO 9001                       |
| ISO 14001                 | ISO 14001                |                                |
| ISO 50001                 | ISO 50001                |                                |
| IATF 16949                | IATF 16949               |                                |
| STOCKO CONTACT<br>Germany | STOCKO CONTACT<br>France | STOCKO CONTACT<br>China (Malu) |

## FOUNDED

- 1901 in Wuppertal

## EMPLOYEES WORLD-WIDE

- 750



■ WUPPERTAL  
Deutschland / Germany



■ HELLENTHAL  
Deutschland / Germany



■ ANDLAU  
Frankreich / France



■ SHANGHAI  
China / China



## STOCKO CONTACT THE SOURCE OF YOUR CONNECTION

### WIR DER PARTNER FÜR ZUVERLÄSSIGE UND HOCHWERTIGE STECKVERBINDERLÖSUNGEN

STOCKO zählt heute zu den führenden europäischen Anbietern von elektromechanischen Bauelementen. Aus gutem Grund. Denn seit mehr als hundert Jahren konzentrieren wir uns bei der täglichen Arbeit auf das Wesentliche: Die Zufriedenheit unserer Kunden.

Die von uns hergestellte und vertriebene Produktpalette reicht von Steckverbindern, Crimp-Kontakten oder Kabelschuhen bis hin zu technologisch sehr anspruchsvollen Verarbeitungsmaschinen.

STOCKO CONTACT verbindet effizient Produkte in vier zentralen Branchen:  
HOME APPLIANCE, HVAC, AUTOMOTIVE und INDUSTRY.

### WE THE PARTNER FOR RELIABLE AND HIGH QUALITY CONNECTOR SOLUTIONS

Today, STOCKO is one of the leading European suppliers of electromechanical components. For good reason. Because for more than a hundred years we have been concentrating on the essentials in our daily work: The satisfaction of our customers.

Our range of manufactured and distributed products includes connectors, crimp contacts, ring terminals, and technologically advanced processing machines.

STOCKO CONTACT efficiently connects products in four central sectors:  
HOME APPLIANCE, HVAC, AUTOMOTIVE and INDUSTRY.

Artikelverzeichnis Index of parts .....	6 - 7
Technische Informationen Technical informations .....	8
Freigaben Approvals .....	9 - 11
Vergleichstabellen Cross-reference lists .....	12 - 13
Flachsteckhülsen Receptacles .....	14 - 24
Flachstecker Tabs .....	25 - 25 / 30 - 34
Leiterplatten-Kontakte Printed boards contacts .....	28 - 29
Krallenkabelschuhe Open barrel terminals .....	35 - 39
Aderendhülsen End splices .....	40 - 44
Rundsteckhülsen Sockets .....	45 - 46
Rundstifte Circular pins .....	47
Sonderanschlußteile Special connectors .....	48
Isolierkörper Insulation housings .....	49 - 61
Crimp-Qualitäts-Übersicht Crimp-quality-chart .....	62
Verarbeitungstechnik Terminating technology.....	63
Allgemeine Sicherheitshinweise General safety informations .....	64 - 65

Kundenzeichnungen und technische Datenblätter aller Produkte erhalten Sie auf Anfrage.  
Customer drawing and data sheet for all products on request.

Technische Änderungen vorbehalten.  
We reserve the right to alter technical details.  
WEEE-Reg.-Nr. DE 14484959

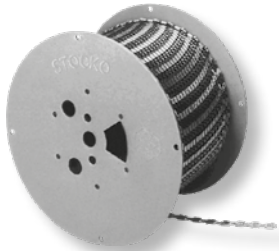

Spulen / Spools Ø: 286 mm / 360 mm



Spulen / Spools Ø: 500 mm



Spulen / Spools Ø: 595 mm



Spulen / Spools Ø: 600 mm / 640 mm

Artikel-Nummer Part number	Spulen Ø Spools Ø mm	Seite Page
-------------------------------	----------------------------	---------------

<b>600</b>		
649 / -G		49
650.100 / -G		49
657.100 / -G		48
658.100 / -G		50
677 / -G		52
678.100 / -B		50
679.200 / -G		50
680 / -G		51
681 / -G		49
683.002 / -G		50
688-002		53
688-003		53
688-004		53
688-005		53
688-006		53
688-007		53
688-008		53
688.400-002		53
688.400-003		53
688.400-004		53
688.400-005		53
688.400-006		53
688.400-007		53
688.400-008		53
694-001		51
699-002		54
699-003		54
699-004		54
699-005		54
699-006		54
699-007		54
699-008		54

<b>700</b>		
700/1-4		55
727.001		55
727.002		55
728		55
761 / -G		51
777 / -G		52
788-002		52
788-003		52
788-004		52
788-005		52
788-006		52
798-003-025-960 / -G		54
798-005-020-960		54

<b>2000</b>		
2023.100 / -G		56
2023.200 / -G		56
2025.100 / -G		57
2025.200 / -G		57
2026.100 / -G		59
2026.200 / -G		59
2027.100 / -G		58

Artikel-Nummer Part number	Spulen Ø Spools Ø mm	Seite Page
-------------------------------	----------------------------	---------------

2027.200 / -G		58
2028.100 / -G		59
2028.110 / -G		60
2028.200 / -G		60
2028.300		60
2029		61
2029.100		61
2029.200		61
2041.100 / -G		58
2041.200 / -G		58

<b>5900</b>		
5920.004	360	28

<b>6000</b>		
6006	500	29
6006.002	500	29
6006.005		29
6006.100	500	29
6007.002	500	29
6008	500	28
6008.001	500	28
6008.002	500	28
6015		30
6015 VS		30
6015.001		30
6015.002		31
6015.003		31
6015.045		33
6015.090		33
6015.145		31
6015.190		31
6015.245		30
6015.290		30
6015.345		30
6015.390		31
6015.445		31
6015.490		30
6015.545		31
6015.590		31
6015.645		30
6015.690		30
6015.745		31
6015.790		31
6015.845		30
6015.890		30
6045		28
6059		32
6059.645		32
6059.690		32
6080		32
6080.045		32
6080.090		32

Artikel-Nummer Part number	Spulen Ø Spools Ø mm	Seite Page
-------------------------------	----------------------------	---------------

<b>6100</b>		
6129		34
6129/2		34
6129.045		34
6129.045/3		34
6129.075/2		34
6129.090		34
6129.090/2		34
6129.090/3		34
6199	360	28

<b>6200</b>		
6201	500	29

<b>7200</b>		
7206	286	36
7207	286	36
7208	286	37
7209	286	37

<b>7600</b>		
7603.028	286	17
7603.105	286	17
7603.108	286	17
7604.001	286	17
7604.258	286	17
7605	286	14
7605.001	286	14
7606	286	14
7607	286	14
7607.001	286	14
7630.158	600	21
7631.258	600	21

<b>7700</b>		
7716.001	286	36
7716.002	286	38
7727	286	35
7735.001	286	42
7738	286	39
7770	286	43
7771	286	43
7779	286	35
7785	286	10
7785.001	286	10
7785.002	286	10
7785.003	286	10
7785.055	286	10
7785.058	286	10
7788	360	37
7788.001	360	38
7791	286	42
7792.002	286	40



Artikel-Nummer Part number	Spulen Ø Spools Ø mm	Seite Page
-------------------------------	----------------------------	---------------

<b>7800</b>		
7806	286	43
7813	286	36
7825.001	286	40
7830	286	39
7830.001	286	39
7831.010	286	27
7832	286	43
7833.010	286	27
7835	286	47
7836	286	45
7837	286	42
7838	286	40
7840	286	27
7843	286	39
7843.001	286	39
7849	286	41
7858	286	21
7858.001	286	21
7861.003	286	47
7877	286	37
7881	286	36
7881.001	286	38
7884.001	360	44
7884.003	360	44
7884.004	360	44
7894	286	42

<b>7900</b>		
7900	286	20
7901	286	20
7908	286	35
7912	286	42
7916	286	21
7916.001	286	21
7918.001	600	48
7918.002	600	48
7923.002	286	38
7929	286	41
7930	286	25
7936.002	286	17
7936.003	286	17

Artikel-Nummer Part number	Spulen Ø Spools Ø mm	Seite Page
-------------------------------	----------------------------	---------------

7942	286	30
7944.010	286	20
7944.258	286	20
7958	286	25
7960.020	286	23
7961.020	286	23
7984	600	17
7984.001	600	17
7990	286	15
7990.001	286	15
7990.055	286	15
7990.058	286	15
7994.002	640	45
7995.003	286	45
7995.005	286	45
7999	286	41

<b>8000</b>		
8006	286	42
8028	286	19
8028.001	286	19
8028.002	286	19
8028.003	286	19
8029	286	19
8029.001	286	19
8029.2258	286	19
8043	286	26
8047	286	23
8048	286	23
8059	640	40
8061	600	43
8064	286	17
8068	600	21
8069	286	46
8069.002	286	46
<b>8100</b>		
8100	286	15
8100.001	286	15
8100.002	286	15
8100.003	286	15
8100.2055	286	15
8100.2058	286	15

Artikel-Nummer Part number	Spulen Ø Spools Ø mm	Seite Page
-------------------------------	----------------------------	---------------

8110	286	45
8110.001	286	45
8113.105	600	15
8113.108	600	15
8113.155	600	15
8115	286	20
8121.020	286	46
8121.022	286	46
8121.025	286	46
8121.115	286	46
8126.010	286	23
8131	286	44
8131.001	286	44
8134.010	286	38
8136	286	22
8137	286	22
8138	286	20
8138.108	286	20
8152	286	20
8165.108	286	26
8168.055	286	18
8168.058	286	18
8168.155	286	18
8168.158	286	18
8178.108	286	23
8178.258	286	23
8178.308	286	23
8178.1108	286	23
8178.1258	286	23
8185	600	46
8186.155	286	18
8186.158	286	18
<b>8200</b>		
8200	360	37
8201	360	37
8202	360	36
8202.108	360	36
8203	360	37
8204	360	37
8205.1158	286	25
8220.1158	286	22
8236	286	40

Artikel-Nummer Part number	Spulen Ø Spools Ø mm	Seite Page
-------------------------------	----------------------------	---------------

8238.158	286	22
8238.258	286	22
8240.158	286	22
8240.258	286	22
8240.1158	286	22
8240.1258	286	22
8260.155	286	21
8260.158	286	21
8260.258	286	21
8261.055	286	16
8261.058	286	16
8261.105	286	16
8261.108	286	16
8270.055	286	18
8270.058	286	18
8270.155	286	18
8270.158	286	18
8270.255	286	18
8270.258	286	18
8271.112	360	24
8280.1055	286	16
8280.1058	286	16
8280.1105	286	16
8280.1108	286	16

<b>8400</b>		
8412	286	42

### Abspulrichtung für Quertransport

### Direction of transverse transport

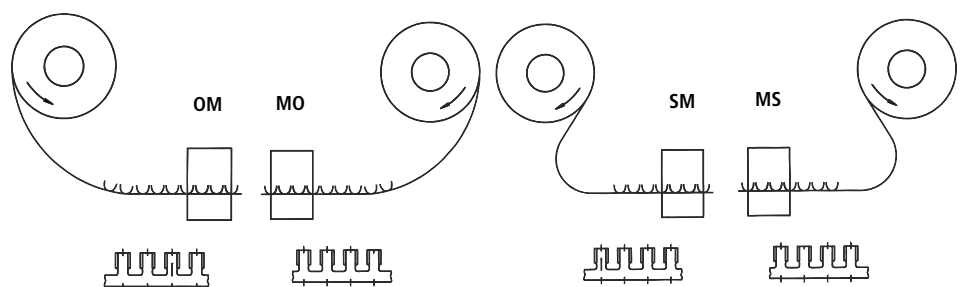

## WERKSTOFFE UND OBERFLÄCHEN

Die eingesetzten Werkstoffe bestimmen das Verhalten und die Eigenschaften der Kontakte. Festigkeit, Federeigenschaften, elektrische Leitfähigkeit und Temperaturverhalten sind wesentliche Kriterien bei der Bewertung der Anwendungen. Messing, Zinnbronze und Stahl sind die gebräuchlichsten Grundmaterialien. Verschiedene Oberflächenbehandlungen erweitern den Anwendungsbereich bei speziellen Anforderungen. Sondermaterialien (z. B. Neusilber) auf Anfrage.

Werkstoff	Zulässige Grenztemperatur	Anwendungsbereich
<b>Messing (CuZn)</b> blank verzinkt (Sn) versilbert (Ag)	110 °C 120 °C 130 °C	Nur für günstige Umgebungsbedingungen, Korrosionsanfällig. Verzinkte Komponenten ergeben gute Leistungen bei höheren Temperaturen und schützen vor Korrosion. Versilberte Komponenten eignen sich für höchste Betriebstemperaturen bei höherer Strombelastung für Messing.
<b>Zinnbronze (CuSn)</b> blank verzinkt (Sn) versilbert (Ag)	120 °C 130 °C 150 °C	Unter korrosiven Bedingungen stabiler als Messing. Verzinkte Komponenten ergeben bei höheren Temperaturen verbesserten Korrosionsschutz. Versilberte Komponenten eignen sich für höchste Betriebstemperaturen bei höherer Strombelastung für Zinnbronze.
<b>Neusilber (CuNiZn)</b> blank	210 °C	Gute Korrosionsbeständigkeit. Erhöhte Festigkeit gegenüber Messing. Hoher elektrischer Widerstand, geringe Wärmeleitfähigkeit.
<b>Stahl (Fe)</b> vernickelt (Ni)	300 °C	Vernickelte Stahlkomponenten ergeben beste zuverlässige Verbindungen bei höheren Temperaturen.

## MATERIALS AND SURFACE FINISHES

The materials used determine the performance and properties of the contacts. Strength, elasticity, electric conductivity and thermal performance are major criteria when it comes to rating different applications. Brass, phosphor bronze and steel are the most common base materials. Different surface finishes extend the application range for specific requirements. Special materials (e. g. nickel silver) on request.

Material	Max. temperature	Application range
<b>Brass (CuZn)</b> unplated tin plated (Sn) silver plated (Ag)	110 °C 120 °C 130 °C	Only for favourable environmental conditions. Susceptible to corrosion. Tin plated components perform well at higher temperatures and are resistant to corrosion. Silver plated components are suitable for highest operating temperatures coupled with higher current loads for brass.
<b>Phosphor bronze (CuSn)</b> unplated tin plated (Sn) silver plated (Ag)	120 °C 130 °C 150 °C	Under corrosive conditions more stable than brass. Tin plated components offer improved resistance to corrosion at higher temperatures. Silver plated components are suitable for highest operating temperatures coupled with higher current loads for tin bronze.
<b>Nickel silver (CuNiZn)</b> unplated	210 °C	Good resistance to corrosion. Stronger than brass. High electric resistance, low thermal conductivity.
<b>Steel (Fe)</b> nickel plated (Ni)	300 °C	Nickel plated steel components produce the most reliable connections at higher temperatures.

## WERKSTOFFDATEN FÜR ISOLIERKÖRPER

### MATERIAL DATA FOR INSULATION HOUSINGS

Werkstoff Material	Temperatur Index nach UL, Details siehe UL-Listing Temperature index acc. to UL, details see UL list
PA 66-V2	- 40 °C .... + 130 °C
PA 6/66-V0	- 40 °C .... + 140 °C
PA 46-V2	- 40 °C .... + 150 °C
PA 6-V2 nach / according to IEC 60335 (auf Anfrage / on request)	- 40 °C .... + 130 °C
PPS V0 nach / according to IEC 60335	- 40 °C .... + 240 °C
PBT V0	- 40 °C .... + 130 °C



VDE-GEPRÜFTE CRIMPKONTAKTE  
VDE TESTED CRIMP CONTACTS

Artikel- Nummer Part number	CuZn blank unplated	CuZn verzinkt tin plated	CuSn blank unplated	CuSn verzinkt tin plated	Fe vernickelt nickel plated	CuNiSi blank unplated	CuNiSi verzinkt tin plated	CuNiZn blank unplated
<b>RSB 7604.258</b>					•			
<b>RMB 7831.010</b>		•						
<b>RMB 7840</b>		•						
<b>RSB 7900</b>	•							
<b>RSB 7944.010</b>	•	•	•	•	•		•	
<b>RSB 7960.020</b>	•	•						
<b>RSB 7961.020</b>	•	•						
<b>RSB 8028</b>		•						•
<b>RSB 8047</b>		•						
<b>RSB 8048</b>		•						
<b>RBB 8110</b>	•				•			
<b>RFB 8121.020</b>					•			
<b>RFB 8121.025</b>					•			
<b>RSB 8138.108</b>	•	•			•			
<b>RMB 8165.108</b>		•						
<b>RSB 8168.055</b>	•	•						
<b>RSB 8168.058</b>	•	•						
<b>RSB 8168.155</b>	•	•						
<b>RSB 8168.158</b>	•	•						
<b>RSB 8178.108</b>	•	•						•
<b>RSB 8178.258</b>	•	•						•
<b>RSB 8186.155</b>	•	•			•			
<b>RSB 8186.158</b>	•	•			•			
<b>RSB 8220.1158</b>					•			
<b>RSB 8238.158</b>	•	•			•			
<b>RSB 8238.258</b>	•	•			•			
<b>RSB 8240.158</b>	•	•			•			
<b>RSB 8240.258</b>	•	•			•			
<b>RSB 8240.1158</b>					•			
<b>RSB 8260.158</b>	•	•			•			
<b>RSB 8260.258</b>	•	•			•			
<b>RSB 8270.055</b>	•	•			•			
<b>RSB 8270.058</b>	•	•			•			
<b>RSB 8270.158</b>	•	•			•			
<b>RSB 8270.258</b>	•	•			•			

STOCKO-Produkte werden in unseren Prüflaboratorien laufend vielfältigen Prüfungen unterzogen. VDE-, UL- und weitere Freigaben für die wichtigen STOCKO-Artikel werden regelmäßig ergänzt. UL-Freigaben und eine einwandfreie Verdrimpfung unserer Produkte sind nur dann gewährleistet, wenn die Verarbeitung auf STOCKO-Werkzeugen erfolgt.

STOCKO products are fully tested at our laboratories. VDE, UL and other approvals for the main STOCKO items are regularly updated. UL approvals and correct crimping only ensured on products crimped with STOCKO applicators.

UL / ULC-FREIGABEÜBERSICHT  
FÜR CRIMPKONTAKTE  
INDEX UL / ULC APPROVALS  
FOR CRIMP CONTACTS

Artikel-Nummer Part number	CuZn blank unplated	CuZn verzinkt tin plated	CuSn blank unplated	CuSn verzinkt tin plated	Fe vernickelt nickel plated	CuNiSi blank unplated	CuNiSi verzinkt tin plated	UL File
<b>RSB 7206</b>					•			E177431
<b>RSB 7605</b>	•	•						E118944
<b>RSB 7605.001</b>	•	•						E118944
<b>RSB 7607</b>	•							E118944
<b>RSB 7630.001</b>	•	•	•		•			E118944
<b>RSB 7630.158</b>	•	•	•	•	•			E118944
<b>RSB 7631.258</b>		•			•			E118944

## UL / ULC-FREIGABEÜBERSICHT FÜR CRIMPKONTAKTE

### INDEX UL / ULC APPROVALS FOR CRIMP CONTACTS

Artikel-Nummer Part number	CuZn blank unplated	CuZn verzinnt tin plated	CuSn blank unplated	CuSn verzinnt tin plated	Fe vernickelt nickel plated	CuNiSi blank unplated	CuNiSi verzinnt tin plated	CuNiZn	UL File
RSB 7785	●	●	●		●				E118944
RSB 7785.001	●	●			●				E118944
RSB 7785.002	●	●			●				E118944
RSB 7785.003	●	●			●				E118944
RSB 7785.055	●	●			●				E118944
RSB 7785.058	●	●			●				E118944
RSB 7788	●	●	●	●					E177431
RMB 7831.010	●	●							E118944
RMB 7833.010	●	●							E118944
RSB 7858		●							E118944
RSB 7858.001		●							E118944
RSB 7900	●	●	●	●	●				E118944
RSB 7901	●	●	●	●	●				E118944
RSB 7923.002	●	●	●	●					E118944
RSB 7944.010	●	●	●	●	●		●		E118944
RSB 7944.258	●	●							E118944
RMB 7958		●							E118944
RSB 7960.020	●	●	●	●				●	E118944
RSB 7961.020	●	●	●	●				●	E118944
RSB 7984	●	●							E118944
RSB 7990	●	●							E118944
RSB 7990.001	●	●							E118944
RBB 7995.003					● (X5CrNi)				E118944
RSB 8028	●	●							E118944
RSB 8028.001		●							E118944
RSB 8029	●	●							E118944
RSB 8029.001	●	●							E118944
RSB 8047		●							E118944
RSB 8100.2055	●				●				E118944
RFB 8121.020					●				E118944
RFB 8121.025					●				E118944
RSB 8126.010	●	●	●	●					E118944
RSB 8137	●	●			●				E118944
RSB 8138	●	●	●	●	●				E118944
RSB 8152				●	●				E118944
RMB 8165.108	●	●							E118944
RSB 8168.055	●	●							E118944
RSB 8168.058	●	●							E118944
RSB 8168.155	●	●							E118944
RSB 8168.158	●	●							E118944
RSB 8178.108	●	●							E118944
RSB 8178.258	●	●							E118944
RSB 8178.308		●							E118944
RSB 8186.155	●	●			●				E118944
RSB 8186.158	●	●			●				E118944
RSB 8238.158	●	●			●				E118944
RSB 8238.258	●	●			●				E118944
RSB 8240.158	●	●			●				E118944
RSB 8240.258	●	●			●				E118944
RSB 8260.158	●	●	●	●	●				E118944
RSB 8260.258	●	●	●	●	●				E118944
RSB 8270.158	●	●			●				E118944
RSB 8270.258	●	●			●				E118944

VDE-Freigabeübersicht  
für Isolierkörper

Index VDE approvals  
for insulation housings

Artikel-Nummer Part number	Farbe Colour	Material-Brennbarkeitsklasse nach Material-Flammability class to UL94		Material-Brennbarkeitsklasse nach Material-Flammability class to IEC 60335 no flame		UL File
		V0	V2	V0	V2	
<b>EH 688-00X</b>	natur	PA 66			PA 6	
<b>EH 688.400-00X</b>	Farben auf Anfrage natural	PA 66			PA 6	
<b>EH 699</b>	colors on request				PA 6	
<b>EH 700</b>	schwarz, black	PA 66				

UL-Freigabeübersicht  
für Isolierkörper

Index UL approvals  
for insulation housings

<b>EH 649</b>		PA 66	PA 66	PA 66	PA 6	E306845
<b>EH 650.100</b>		PA 6/66	PA 66		PA 6	E306845
<b>EH 650.200</b>		PA 6/66	PA 66			E306845
<b>EH 657.100</b>		PA 6/66	PA 66		PA 6	E306845
<b>EH 658.100</b>			PA 66		PA 6	E306845
<b>EH 677</b>			PA 66	PA 66		E306845
<b>EH 678.100</b>			PA 66	PA 66		E306845
<b>EH 679.200</b>		PA 6/66	PA 66		PA 6	E306845
<b>EH 680</b>		PA 6/66	PA 66		PA 6	E306845
<b>EH 681</b>		PA 6/66	PA 66		PA 6	E306845
<b>EH 683.002</b>		PA 6/66	PA 66		PA 6	E306845
<b>EH 688-00X</b>	natur	PA 6		PA 6		E306640
<b>EH 688.400-00X</b>	Farben auf Anfrage	PA 6		PA 6		E306640
<b>EH 694-001</b>		PA 6		PA 6		E191950
<b>EH 699</b>	natural	PA 6		PA 6	PA 6	E306640
<b>EH 777</b>		PA 66	PA 66	PA 66	PA 6	E306845
<b>EH 798.003</b>		PA 6/66			PA 6	E306845
<b>EH 798.005</b>		PA 6/66			PA 6	E306845
<b>VV 2023.100</b>		PA 6/66	PA 66		PA 6	E306845
<b>VV 2023.200</b>			PA 66		PA 6	E306845
<b>VV 2025.100</b>			PA 66		PA 6	E306845
<b>VV 2025.200</b>			PA 66		PA 6	E306845
<b>VV 2026.100</b>			PA 66		PA 6	E306845
<b>VV 2026.200</b>			PA 66		PA 6	E306845
<b>VV 2027.100</b>			PA 66		PA 6	E306845
<b>VV 2027.200</b>			PA 66		PA 6	E306845
<b>VV 2028.100</b>			PA 66		PA 6	E306845
<b>VV 2028.110</b>			PA 66		PA 6	E306845
<b>VV 2028.200</b>			PA 66		PA 6	E306845
<b>VV 2028.300</b>			PA 66			E306845
<b>VV 2029</b>			PA 66			E306845
<b>VV 2029.100</b>			PA 66			E306845
<b>VV 2029.200</b>			PA 66			E306845
<b>VV 2041.100</b>			PA 66		PA 6	E306845
<b>VV 2041.200</b>			PA 66		PA 6	E306845

STOCKO-Produkte werden in unseren Prüflaboratorien laufend vielfältigen Prüfungen unterzogen. VDE-, UL- und weitere Freigaben für die wichtigen STOCKO-Artikel werden regelmäßig ergänzt.

STOCKO products are fully tested at our laboratories. VDE, UL and other approvals for the main STOCKO items are regularly updated. UL approvals and correct crimping only ensured on products crimped with STOCKO applicators.

# VERGLEICHSTABELLEN CROSS-REFERENCE LISTS

Umrechnung des Inch  
Equivalents of an Inch

Übersicht der gängigen Leiter  
nach VDE 0250 / 4.64

Cable chart of wire sizes to  
VDE 0250 / 4.64 specification

Fraction inch	Decimal inch	Millimeter mm
1/64	.015625	0.397
1/32	.031250	0.794
3/64	.046875	1.191
1/16	.062500	1.588
5/64	.078125	1.984
3/32	.093750	2.381
7/64	.109375	2.778
1/8	.125000	3.175
9/64	.140625	3.572
5/32	.156250	3.969
11/64	.171875	4.366
3/16	.187500	4.763
13/64	.203125	5.159
7/32	.218750	5.556
15/64	.234375	5.953
1/4	.250000	6.350
17/64	.265625	6.747
9/32	.281250	7.144
19/64	.296875	7.541
5/16	.312500	7.938
21/64	.328125	8.334
11/32	.343750	8.731
23/64	.359375	9.128
3/8	.375000	9.525
25/64	.390625	9.922
13/32	.406250	10.319
27/64	.421875	10.716
7/16	.437500	11.113
29/64	.453125	11.509
15/32	.468750	11.906
31/64	.484375	12.303
1/2	.500000	12.700
33/64	.515625	13.097
17/32	.531250	13.494
35/64	.546875	13.891
9/16	.562500	14.288
37/64	.578125	14.684
19/32	.593750	15.081
39/64	.609375	15.478
5/8	.625000	15.875
41/64	.640625	16.272
21/32	.656250	16.669
43/64	.671875	17.066
11/16	.687500	17.463
45/64	.703125	17.859
23/32	.718750	18.256
47/64	.734375	18.653
3/4	.750000	19.050
49/64	.765625	19.447
25/32	.781250	19.844
51/64	.796875	20.241
13/16	.812500	20.638
53/64	.828125	21.034
27/32	.843750	21.431
55/64	.859375	21.828
7/8	.875000	22.225
57/64	.890625	22.622
29/32	.906250	23.019
59/64	.921875	23.416
15/16	.937500	23.813
61/64	.953125	24.209
31/32	.968750	24.606
63/64	.984375	25.003
1	1.000000	25.400

mm <sup>2</sup>	Anzahl und Ø der Leiterdrähte No. and dia. of strands mm	Leiter-Ø Wire dia. mm max.
0,5	1 x 0,80	0,8
	7 x 0,30	0,9
	16 x 0,20	0,9
0,75	1 x 1,00	1,0
	7 x 0,37	1,1
1	24 x 0,20	1,2
	1 x 1,13	1,13
	7 x 0,43	1,3
	19 x 0,25	1,3
1,5	32 x 0,20	1,3
	1 x 1,38	1,38
	7 x 0,52	1,6
	21 x 0,30	1,6
2,5	30 x 0,25	1,7
	189 x 0,10	1,9
	1 x 1,78	1,78
	7 x 0,67	2,1
4	35 x 0,30	2,2
	50 x 0,25	2,2
	315 x 0,10	2,2
	1 x 2,26	2,26
6	19 x 0,52	2,7
	56 x 0,30	3,1
	511 x 0,10	3,0
	1 x 2,76	2,76
10	7 x 1,05	3,2
	19 x 0,64	3,3
	84 x 0,30	3,5
	756 x 0,10	3,7
16	1 x 3,57	3,57
	7 x 1,35	4,1
	19 x 0,80	4,3
	49 x 0,51	4,6
	80 x 0,40	5,0
16	1197 x 0,10	4,5
	1 x 4,52	4,52
	7 x 1,70	5,2
	37 x 0,75	5,6
	49 x 0,65	5,9
	128 x 0,40	6,0
2058 x 0,10	6,8	

## Umrechnung der gängigen amerikanischen Leiter

### Conversion table of American Wire Sizes

AWG #	Circ. Mils.	A = mm <sup>2</sup>
26	238 - 300	0,12 - 0,15
24	315 - 477	0,16 - 0,24
22	600 - 750	0,30 - 0,38
20	1000 - 1200	0,51 - 0,61
18	1600 - 1900	0,81 - 0,96
16	2400 - 2830	1,22 - 1,43
14	3830 - 4500	1,94 - 2,28
12	6100 - 6700	3,09 - 3,40
10	9000 - 13100	4,56 - 6,64
8	13200 - 16900	6,69 - 8,56
6	22800 - 30900	11,55 - 15,66

AWG #	Circ. Mils.	A = mm <sup>2</sup>
4	38900 - 49100	19,71 - 24,88
2	60100 - 66800	30,45 - 33,85
1	75800 - 84000	38,41 - 42,56
1/0	99100 - 105800	50,21 - 53,61
2/0	124900 - 133800	63,29 - 67,80
3/0	157600 - 168000	79,86 - 85,12
4/0	198700 - 212200	100,68 - 107,52
250 - 300 MCM	250000 - 300000	117 - 151
300 - 350 MCM	300000 - 350000	151 - 192
400 MCM	400000	205
500 - 600 MCM	500000 - 600000	252 - 304

### AWG = American Wire Gauge

Circ. Mils.: Der Circ. Mils.-Wert eines Kreises mit d = 1 Mil. beträgt:  
 1 x 1 = 1 Circ. Mil. (1 Mil. = 0,001 inch = 0,0254 mm)  
 1 Circ. Mil. = 0,0005066 mm<sup>2</sup>  
 1 mm<sup>2</sup> = 1973,51 Circ. Mils.

Formel zur Bestimmung des Leiterquerschnittes

$$A = \frac{d^2 \cdot p}{4} \times n$$

A = Leiterquerschnitt in mm<sup>2</sup>  
 n = Anzahl Einzeldrähte

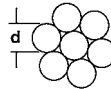

### AWG = American Wire Gauge

Circular Mil Area (CMA): Area of a circle of 1 mil diameter  
 1 x 1 = 1 Circ. Mil. (1 Mil. = 0.001 inch = 0.0254 mm)  
 1 Circ. Mil. = 0.0005066 mm<sup>2</sup>  
 1 mm<sup>2</sup> = 1973.51 Circ. Mils.

Formula to determine the wire size

$$A = \frac{d^2 \cdot p}{4} \times n$$

A = Wire size in mm<sup>2</sup>  
 n = Number of strands

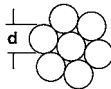

## Anschlußbolzen

### Standard stud-bolts

DIN	USA	British Assoc.
M 2	1 = 1,9 mm	9 BA = 1,9 mm
	2 = 2,2 mm	8 BA = 2,2 mm
M 2,6	3 = 2,5 mm	7 BA = 2,5 mm
M 3	4 = 2,8 mm	6 BA = 2,8 mm
	5 = 3,2 mm	5 BA = 3,2 mm
M 3,5	6 = 3,5 mm	4 BA = 3,5 mm
M 4	8 = 4,2 mm	3 BA = 4,2 mm
M 5	10 = 4,8 mm	2 BA = 4,8 mm
M 6	12 = 5,5 mm	1 BA = 5,5 mm
	14 = 6,1 mm	0 BA = 6,1 mm
	1/4" = 6,35 mm	1/4" = 6,35 mm

DIN	USA	British Assoc.
M 8	5/16" = 7,9 mm	5/16" = 7,9 mm
M 10	3/8" = 9,5 mm	3/8" = 9,5 mm
M 12	7/16" = 11,1 mm	7/16" = 11,1 mm
	1/2" = 12,7 mm	1/2" = 12,7 mm
M 16	5/8" = 15,8 mm	5/8" = 15,8 mm
M 20	3/4" = 19,0 mm	3/4" = 19,0 mm
M 26	1" = 25,4 mm	1" = 25,4 mm

# FLACHSTECKHÜLSEN RECEPTACLES

■ Flachsteckhülsen für Steckbreite 2,8 mm

■ Receptacles for tab width 2,8 mm

Bauform Q = Quertransport L = Längstransport  Supply condition Q = transverse transport / Side feed L = longitudinal transport / End feed	Artikel-Nummer  Part number	DIN	Frei- gaben- s. Seiten 7/8 Appro- vals s. page 7/8	Leiter- quer- schnitt  Wire size  mm <sup>2</sup> AWG	Material	Veredlung			Länge		Steck- dicke  Tab thick- ness  mm	Rast- posi- tion  Inden- tation	Verp.-Einh. Bandform  Packing unit Chain form  x 1000
						blank	Sn	Ni	L 1 mm	L 2 mm			
						un- plated	Sn	Ni					

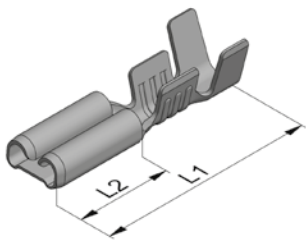

L

<b>RSB 7605 F 2,8-0,25</b>			0,13-0,35	CuSn	○	○	12,5	5,0	0,8	DIN	25
	●		26-22	CuZn	●	●					
<b>RSB 7605.001 F 2,8-0,25</b>			0,13-0,35	CuSn	○	○	12,5	5,0	0,5	DIN	25
	●		26-22	CuZn	●	●					
<b>RSB 7607 F 2,8-0,5</b>			0,22-0,75	CuSn	○	○	12,5	5,0	0,8	DIN	25
	●		24-20	CuZn	●	●					
<b>RSB 7607.001 F 2,8-0,5</b>			0,22-0,75	CuSn	●	○	12,5	5,0	0,5	DIN	25
			24-20	CuZn	○	○					
<b>RSB 7606 F 2,8-1</b>		46330 T2 A 2,8-1	0,5-1	CuSn	●		12,5	5,0	0,8	DIN	18
			20-18	CuZn		●					
<b>RSB 7785.058 F 2,8-0,5</b>	●		0,22-0,5	CuSn	○	○	14,0	6,3	0,8	DIN	18
	●		24-20	CuZn	○	○					
	●			Fe		○					
<b>RSB 7785.055 F 2,8-0,5</b>	●		0,22-0,5	CuSn	○	○	14,0	6,3	0,5	DIN	18
	●		24-20	CuZn	○	○					
	●			Fe		○					
<b>RSB 7785 F 2,8-1</b>	●		0,5-1	CuSn	○	○	14,0	6,3	0,5	IEC	18
	●		20-18	CuZn	●	●					
	●			Fe		●					
<b>RSB 7785.001 F 2,8-1</b>	●		0,5-1	CuSn	○	○	14,0	6,3	0,8	IEC	18
	●		20-18	CuZn	●	●					
	●			Fe		●					
<b>RSB 7785.002 F 2,8-1</b>	●	46247 T1 A 2,8-1	0,5-1	CuSn	○	○	14,0	6,3	0,5	DIN	18
	●		20-18	CuZn	●	●					
	●			Fe		○					
<b>RSB 7785.003 F 2,8-1</b>	●	46247 T1 B 2,8-1	0,5-1	CuSn	●	●	14,0	6,3	0,8	DIN	18
	●		20-18	CuZn	●	●					
	●			Fe		○					

● Standard-Artikel / Standard parts ○ lieferbar auf Anfrage / available on request

■ Flachsteckhülsen für Steckbreite 2,8 mm

■ Receptacles for tab width 2,8 mm

Bauform Q = Quertransport L = Längstransport  Supply condition Q = transverse transport / Side feed L = longitudinal transport / End feed	Artikel-Nummer  Part number	DIN	Frei- gaben- s. Seiten 7/8 Appro- vals s. page 7/8	Leiter- quer- schnitt  Wire size  mm <sup>2</sup> AWG	Material	Veredlung			Länge		Steck- dicke  Tab thick- ness  mm	Rast- posi- tion  Inden- tation	Verp.-Einh. Bandform  Packing unit Chain form  x 1000
						blank	Sn	Ni	L 1 mm	L 2 mm			
						un- plated	Sn	Ni					

Nicht entriegelbar  
Permanently engaged

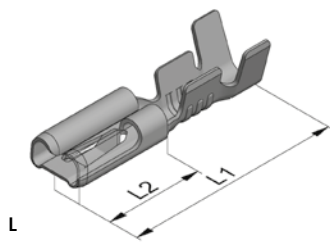

<b>RSB 7990.058 F 2,8-0,5</b>	0,22-0,5 24-20	CuZn	○	●	13,8	6,4	0,8	18	
		Fe		○					
	<b>RSB 7990.055 F 2,8-0,5</b>	0,22-0,5 24-20	CuZn	○	○	13,8	6,4	0,5	18
			Fe		○				
<b>RSB 7990 F 2,8-1</b>	● 0,5-1 20-18	CuZn	●	○	13,8	6,4	0,8	18	
		Fe		○					
<b>RSB 7990.001 F 2,8-1</b>	● 0,5-1 20-18	CuZn	●	●	13,8	6,4	0,5	18	
		Fe		○					

Leicht aufsteckbar  
Low insertion force

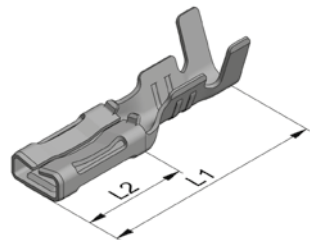

<b>RSB 8100 F 2,8-1</b>	0,5-1 20-18	CuSn	○	○	14,0	6,4	0,8	DIN	14
		CuZn	●	●					
		Fe		○					
<b>RSB 8100.001 F 2,8-1</b>	0,5-1 20-18	CuSn	○	○	14,0	6,4	0,5	DIN	14
		CuZn	○	●					
		Fe		○					
<b>RSB 8100.002 F 2,8-1</b>	0,5-1 20-18	CuSn	○	○	14,0	6,4	0,5	IEC	14
		CuZn	●	●					
		Fe		○					
<b>RSB 8100.003 F 2,8-1</b>	0,5-1 20-18	CuZn		●	14,0	6,4	0,8	IEC	14
		Fe		○					
<b>RSB 8100.2055 F 2,8-0,5</b>	0,22-0,5 24-20	CuSn	○	○	14,0	6,4	0,5	IEC	14
		CuZn	●	○					
		Fe		○					
<b>RSB 8100.2058 F 2,8-0,5</b>	0,22-0,5 24-20	CuSn	○	○	14,0	6,4	0,8	IEC	14
		CuZn	○	○					
		Fe		●					

Timer-Kontakt  
Timer contact

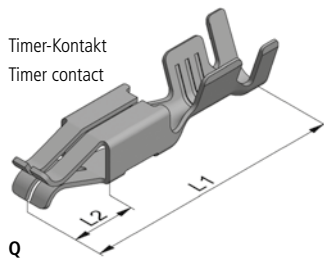

<b>RFB 8113.105 F 2,8-1</b> Für Gehäusemontage For housings	0,5-1 20-18	CuSn	○	○	18,7	5,0	0,5	4,5
		CuZn	○	●				
<b>RFB 8113.108 F 2,8-1</b> Für Gehäusemontage For housings	0,5-1 20-18	CuSn	○	○	18,7	5,0	0,8	4,5
		CuZn	○	●				
<b>RFB 8113.155 F 2,8-1,5</b> Für Gehäusemontage For housings	0,75-1,5 18-14	CuSn	○	○	18,7	5,0	0,5	4
		CuZn	○	●				

● Standard-Artikel / Standard parts   ○ lieferbar auf Anfrage / available on request



# FLACHSTECKHÜLSEN RECEPTACLES

■ Flachsteckhülsen für Steckbreite 2,8 mm

■ Receptacles for tab width 2,8 mm

Bauform Q = Quertransport L = Längstransport  Supply condition Q = transverse transport / Side feed L = longitudinal transport / End feed	Artikel-Nummer  Part number	DIN	Frei- gaben- s. Seiten 7/8  Appro- vals s. page 7/8	Leiter- quer- schnitt  Wire size  mm <sup>2</sup> AWG	Material	Veredlung			Länge		Steck- dicke  Tab thick- ness  mm	Rast- posi- tion  Inden- tation	Verp.-Einh. Bandform  Packing unit Chain form  x 1000
						blank	Sn	Ni	L 1 mm	L 2 mm			
						un- plated	Sn	Ni					

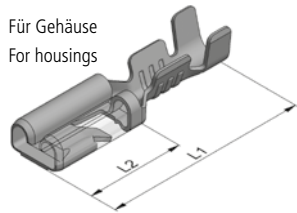

L

<b>RSB 8280.1055 F 2,8-0,5</b>	46340 T1			0,22-0,5 24-22	CuZn	●	●		14,0	6,0	0,5		19
<b>RSB 8280.1058 F 2,8-0,5</b>	46340 T1			0,22-0,5 24-22	CuZn	●	●		14,0	6,0	0,8		19
<b>RSB 8280.1105 F 2,8-1</b>	46340 T1			0,5-1 20-18	CuZn	●	●		14,0	6,0	0,5		14
<b>RSB 8280.1108 F 2,8-1</b>	46340 T1			0,5-1 20-18	CuZn	●	●		14,0	6,0	0,8		14

Verriegelung, leicht aufsteckbar  
Self locking, low insertion force

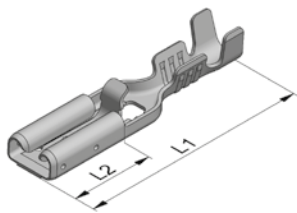

L

<b>RSB 8261.055 F 2,8-0,5</b>				0,35-0,5 22-20	CuZn		●		17	6,2	0,5	DIN	15
<b>RSB 8261.058 F 2,8-0,5</b>				0,35-0,5 22-20	CuZn		●		17	6,2	0,8	DIN	15
<b>RSB 8261.105 F 2,8-1</b>				0,5-1 20-18	CuZn		●		17	6,2	0,5	DIN	15
<b>RSB 8261.108 F 2,8-1</b>				0,5-1 20-18	CuZn		●		17	6,2	0,8	DIN	15

● Standard-Artikel / Standard parts   ○ lieferbar auf Anfrage / available on request

■ Flachsteckhülsen für Steckbreite 4,8 mm

■ Receptacles for tab width 4,8 mm

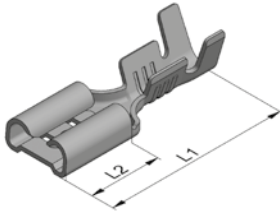
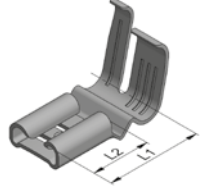
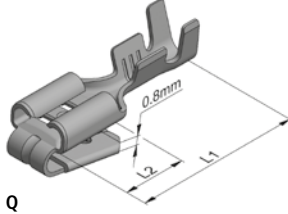
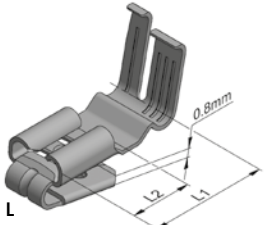
Bauform Q = Quertransport L = Längstransport  Supply condition Q = transverse transport / Side feed L = longitudinal transport / End feed	Artikel-Nummer  Part number	DIN	Frei- gaben- s. Seiten 7/8 Appro- vals s. page 7/8	Leiter- quer- schnitt  Wire size  mm <sup>2</sup> AWG	Material	Veredlung			Länge		Steck- dicke  Tab thick- ness  mm	Rast- posi- tion  Inden- tation	Verp.-Einh. Bandform  Packing unit Chain form  x 1000
						blank	Sn	Ni	L 1 mm	L 2 mm			
						un- plated	Sn	Ni					
	<b>RSB 7603.028 F 4,8-0,2</b>			0,13-0,35 24-22	CuSn CuZn Fe	○ ○ ○	○ ○ ○		16,0 6,3	0,8	DIN	12	
	<b>RSB 7603.108 F 4,8-1</b>	46247 T2 4,8-1		0,5-1 20-18	CuSn CuZn Fe	○ ● ○	● ● ●		16,0 6,3	0,8	DIN	10	
	<b>RSB 7603.105 F 4,8-1</b>			0,5-1 20-18	CuSn CuZn Fe	○ ● ○	○ ● ○		16,0 6,3	0,5	DIN	10	
	<b>RSB 7604.258 F 4,8-2,5</b>	46247 T2 4,8-2,5		1,5-2,5 16-14	CuSn CuZn Fe	○ ● ○	○ ● ○		16,0 6,3	0,8	DIN	10	
	<b>RSB 7604.001 F 4,8-2,5</b>			1,5-2,5 16-14	CuSn CuZn Fe	○ ○ ○	○ ○ ○		16,0 6,3	0,5	DIN	10	
	<b>RSB 7936.002 F 4,8-1,5</b>			0,5-1,5 20-16	CuSn CuZn Fe	○ ○ ○	○ ● ○		10,0 6,0	0,8	DIN	3	
	<b>RSB 7936.003 F 4,8-1,5</b>			0,5-1,5 20-16	CuSn CuZn Fe	○ ● ○	○ ● ○		10,0 6,0	0,5	DIN	3	
	<b>RSB 7984 X 4,8-1,5</b>		●	0,5-1,5 20-16	CuZn	●	●		16,0 6,0	0,8	DIN	2,5	
	<b>RSB 7984.001 X 4,8-1,5</b>			0,5-1,5 20-16	CuZn	○	○		16,0 6,0	0,5	DIN	2,5	
	<b>RSB 8064 X 4,8-1,5</b>			0,5-1,5 20-16	CuZn	○	○		11,5 6,0	0,8	DIN	2,5	

● Standard-Artikel / Standard parts    ○ lieferbar auf Anfrage / available on request

# FLACHSTECKHÜLSEN RECEPTACLES

■ Flachsteckhülsen für Steckbreite 4,8 mm

■ Receptacles for tab width 4,8 mm

Bauform Q = Quertransport L = Längstransport  Supply condition Q = transverse transport / Side feed L = longitudinal transport / End feed	Artikel-Nummer  Part number	DIN	Frei- gaben- s. Seiten 7/8  Appro- vals s. page 7/8	Leiter- quer- schnitt  Wire size  mm <sup>2</sup> AWG	Material	Veredlung			Länge		Steck- dicke  Tab thick- ness  mm	Rast- posi- tion  Inden- tation	Verp.-Einh. Bandform  Packing unit Chain form  x 1000
						blank	Sn	Ni	L 1 mm	L 2 mm			
						un- plated	Sn	Ni					

Leicht aufsteckbar  
Low insertion force

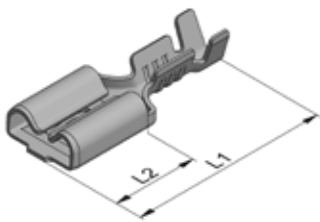

L

<b>RSB 8270.058 F 4,8-0,5</b>		0,22 - 0,5	CuSn	○	○	14,5	6,2	0,8	DIN	18
	●	24 - 20	CuZn	●	●					
	●		Fe		●					
<b>RSB 8270.055 F 4,8-0,5</b>		0,22 - 0,5	CuSn	○	○	14,5	6,2	0,5	DIN	18
	●	24 - 20	CuZn	●	●					
	●		Fe		●					
<b>RSB 8270.158 F 4,8-1,5</b>		0,75 - 1,5	CuSn	○	○	14,5	6,2	0,8	DIN	14
	●	18 - 16	CuZn	●	●					
	●		Fe		●					
<b>RSB 8270.155 F 4,8-1,5</b>		0,75 - 1,5	CuSn	○	○	14,5	6,2	0,5	DIN	14
	●	18 - 16	CuZn	●	●					
	●		Fe		●					
<b>RSB 8270.258 F 4,8-2,5</b>	●	1,5 - 2,5	CuSn	○	○	14,5	6,2	0,8	DIN	9
	●	16 - 14	CuZn	●	●					
	●		Fe		●					
<b>RSB 8270.255 F 4,8-2,5</b>		1,5 - 2,5	CuSn	○	○	14,5	6,2	0,5	DIN	9
	●	16 - 14	CuZn	○	○					
	●		Fe		○					

Leicht aufsteckbar  
Low insertion force

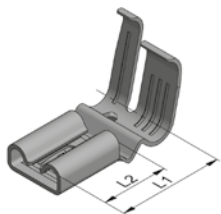

L

<b>RSB 8186.158 F 4,8-1,5</b>	●	0,5-1,5	CuSn	○	○	10,0	6,0	0,8	DIN	3
	●	20-16	CuZn	●	●					
	●		Fe		●					
<b>RSB 8186.155 F 4,8-1,5</b>	●	0,5-1,5	CuSn	○	○	10,0	6,0	0,5	DIN	3
	●	20-16	CuZn	●	●					
	●		Fe		●					

Verriegelbar, leicht aufsteckbar  
Self locking, low insertion force

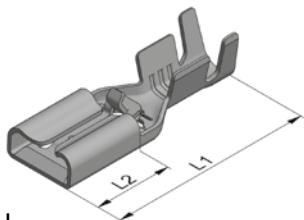

L

<b>RSB 8168.058 F 4,8-0,5</b>	●	0,22-0,75 24-20	CuSn	○	○	16,3	6,3	0,8	DIN	10
			CuZn	●	●					
			CuNiZn	○						
<b>RSB 8168.055 F 4,8-0,5</b>	●	0,22-0,75 24-20	CuSn	○	○	16,3	6,3	0,5		10
			CuZn	●	●					
			CuNiZn	○						
<b>RSB 8168.158 F 4,8-1,5</b>	●	1-1,5 18-14	CuSn	○	○	16,3	6,3	0,8	DIN	10
			CuZn	●	●					
			CuNiZn	○						
<b>RSB 8168.155 F 4,8-1,5</b>	●	1-1,5 18-14	CuSn	○	○	16,3	6,3	0,5		10
			CuZn	●	●					
			CuNiZn	○						

● Standard-Artikel / Standard parts ○ lieferbar auf Anfrage / available on request

■ Flachsteckhülsen für Steckbreite 4,8 mm

■ Receptacles for tab width 4,8 mm

Bauform Q = Quertransport L = Längstransport  Supply condition Q = transverse transport / Side feed L = longitudinal transport / End feed	Artikel-Nummer  Part number	Frei- gaben- s. Seiten 7/8 Appro- vals s. page 7/8	Leiter- quer- schnitt  Wire size  mm <sup>2</sup> AWG	Material	Veredlung			Länge		Steck- dicke  Tab thick- ness  mm	Rast- posi- tion  Inden- tation	Verp.-Einh. Bandform  Packing unit Chain form  x 1000
					blank	Sn	Ni	L 1 mm	L 2 mm			

Verriegelbar  
Self locking

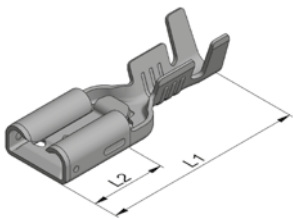

L

<b>RSB 8028 F 4,8-1</b>		0,5-1	CuSn	○	●		17,0	6,3	0,8	DIN	9
	●	20-18	CuZn	●	●	●					
			CuNiZn	○							
<b>RSB 8028.001 F 4,8-1</b>	●	0,5-1 20-18	CuZn		●		17,0	6,3	0,5	DIN	9
<b>RSB 8029 F 4,8-2,5</b>		1,5-2,5	CuSn	○	○		17,0	6,3	0,8	DIN	9
	●	16-14	CuZn	●	●						
			CuNiZn	○							
<b>RSB 8029.001 F 4,8-2,5</b>		1,5-2,5	CuSn	○	○		17,0	6,3	0,5	DIN	9
	●	16-14	CuZn	○	●						
			CuNiZn	○							

Nicht entriegelbar  
Permanently engaged

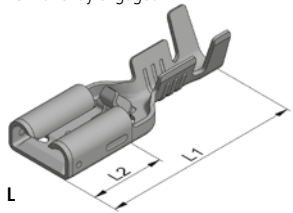

L

<b>RSB 8028.002 F 4,8-1</b>		0,5-1 20-18	CuSn	○	○		17,0	6,3	0,8	DIN	9
			CuZn	○	●						
			CuNiZn	○							
<b>RSB 8028.003 F 4,8-1</b>		0,5-1 20-18	CuSn	○	○		17,0	6,3	0,5	DIN	9
			CuZn	○	○						
			CuNiZn	○							
<b>RSB 8029.2258 F 4,8-2,5</b>		1,5-2,5 16-14	CuZn		●	○	17,0	6,3	0,8	DIN	9

● Standard-Artikel / Standard parts   ○ lieferbar auf Anfrage / available on request

# FLACHSTECKHÜLSEN RECEPTACLES

■ Flachsteckhülsen für Steckbreite 6,3 mm

■ Receptacles for tab width 6,3 mm

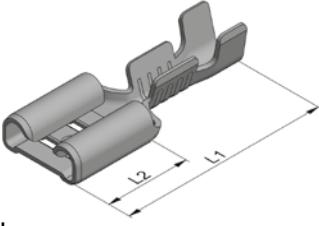
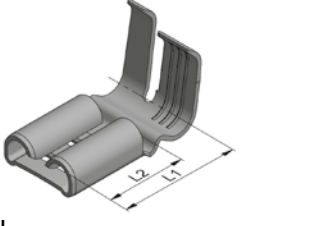
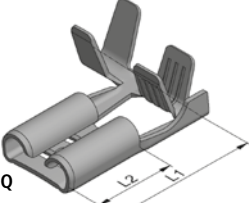
Bauform Q = Quertransport L = Längstransport  Supply condition Q = transverse transport / Side feed L = longitudinal transport / End feed	Artikel-Nummer  Part number	DIN	Frei- gaben- s. Seiten 7/8 Appro- vals s. page 7/8	Leiter- quer- schnitt  Wire size  mm <sup>2</sup> AWG	Material	Veredlung			Länge		Steck- dicke  Tab thick- ness  mm	Rast- posi- tion  Inden- tation	Verp.-Einh. Bandform  Packing unit Chain form  x 1000
						blank	Sn	Ni	L 1 mm	L 2 mm			
						Finishing							
 <p>L</p>	<b>RSB 8115 F 6,3-0,2</b>			0,13-0,35 26-22	CuSn	○	○	19,0	7,7	0,8	DIN	8	
					CuZn	○	○						
					Fe		○						
	<b>RSB 7900 F 6,3-1</b>	46247 T3 6,3-1	●	0,5-1,5 20-16	CuSn	●	●	19,0	7,7	0,8	DIN	8	
					CuZn	●	●						
					Fe		●						
	<b>RSB 7901 F 6,3-2,5</b>	46247 T3 6,3-2,5	●	1,5-2,5 16-14	CuSn	●	●	19,0	7,7	0,8	DIN	6	
					CuZn	●	●						
					Fe		●						
	<b>RSB 8152 F 6,3-6</b>	46247 T3 6,3-6	●	2,5-6 14-10	CuSn		●	19,0	7,7	0,8	DIN	5	
					CuZn		●						
					Fe		●						
 <p>L</p>	<b>RSB 7944.010 F 6,3-1,5</b>	46346	●	0,5-1,5 20-16	CuSn	○	○	11,5	7,7	0,8	DIN	2	
					CuZn	●	●						
					Fe		●						
					CuNiSi	○	○						
	<b>RSB 7944.258 F 6,3-2,5</b>		●	1,5-2,5 16-14	CuSn	○	○	11,5	7,7	0,8	DIN	1,8	
					CuZn	●	●						
					Fe		●						
 <p>Q</p>	<b>RSB 8138 F 6,3-2,5</b>	46346	●	1-2,5 16-14	CuSn	○	○	14,2	7,7	0,8	DIN	3,5	
					CuZn	●	○						
					Fe		●						
	<b>RSB 8138.108 F 6,3-1</b>	46346	●	0,5-1 20-18	CuZn	●	●	14,2	7,7	0,8	DIN	8	
					Fe		●						

● Standard-Artikel / Standard parts ○ lieferbar auf Anfrage / available on request

■ Flachsteckhülsen für Steckbreite 6,3 mm

■ Receptacles for tab width 6,3 mm

Bauform Q = Quertransport L = Längstransport  Supply condition Q = transverse transport / Side feed L = longitudinal transport / End feed	Artikel-Nummer  Part number	DIN	Frei- gaben s. Seiten 7/8  Appro- vals s. page 7/8	Leiter- quer- schnitt  Wire size  mm <sup>2</sup> AWG	Material	Veredlung			Länge		Steck- dicke  Tab thick- ness  mm	Rast- posi- tion  Inden- tation	Verp.-Einh. Bandform  Packing unit Chain form  x 1000	Win- kel  Angle
						blank	Sn	Ni	L 1 mm	L 2 mm				
						Finishing								
						un- plated	Sn	Ni						

Für Gehäuse  
For housings

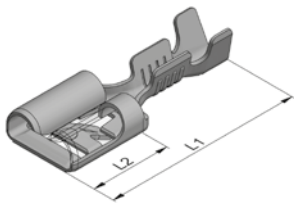

L

<b>RSB 7916 F 6,3-1</b>	46340 T3 A 6,3-1			0,5-1,5 20-16	CuZn	●	●		20	7,7	0,8		6	
<b>RSB 7916.001 F 6,3-1</b>	46340 T3 B 6,3-1			0,5-1,5 20-16	CuSn CuZn		○		20	7,7	0,8	DIN	6	
<b>RSB 7858 F 6,3-2,5</b>	46340 T3 A 6,3-2,5		●	1-2,5 18-14	CuSn CuZn		○		20	7,7	0,8		6	
<b>RSB 7858.001 F 6,3-2,5</b>	46340 T3 B 6,3-2,5		●	1-2,5 18-14	CuSn CuZn	●	●		20	7,7	0,8	DIN	6	

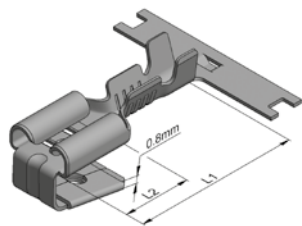

Q

<b>RSB 7630.158 X 6,3-1,5</b> Mit einem Bandträger With a unique carrier strip	46345 6,3-1		●	0,5-1,5 20-16	CuSn CuZn Fe	●	●		19,8	7,7	0,8	DIN	1,4	10°
<b>RSB 7631.258 X 6,3-2,5</b> Mit einem Bandträger With a unique carrier strip	46345 6,3-2,5		●	1,25-2,5 16-14	CuSn CuZn Fe	○	○		19,8	7,7	0,8	DIN	1,3	10°

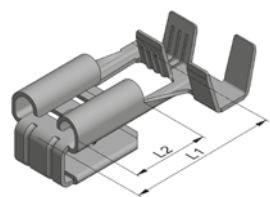

L

<b>RSB 8068 F 6,3-2,5</b>				1-2,5 16-14	CuZn	○	●		14,8	7,6	0,8	DIN	1,5	
---------------------------	--	--	--	----------------	------	---	---	--	------	-----	-----	-----	-----	--

Leicht aufsteckbar  
Low insertion force

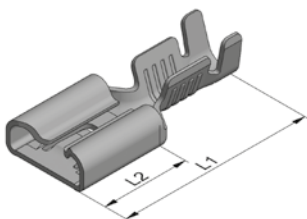

L

<b>RSB 8260.155 F 6,3-1,5</b>				0,5-1,5 20-16	CuZn Fe	●	○		17,15	7,7	0,5	DIN	8	
<b>RSB 8260.158 F 6,3-1,5</b>			●	0,5-1,5 20-16	CuSn CuZn Fe	○	○		17,15	7,7	0,8	DIN	8	
<b>RSB 8260.258 F 6,3-2,5</b>			●	1,5-2,5 16-14	CuSn CuZn Fe	○	○		17,15	7,7	0,8	DIN	6	

● Standard-Artikel / Standard parts    ○ lieferbar auf Anfrage / available on request

# FLACHSTECKHÜLSEN RECEPTACLES

## Flachsteckhülsen für Steckbreite 6,3 mm

## Receptacles for tab width 6,3 mm

Bauform Q = Quertransport L = Längstransport  Supply condition Q = transverse transport / Side feed L = longitudinal transport / End feed	Artikel-Nummer  Part number	DIN	Frei- gaben- s. Seiten 7/8  Appro- vals s. page 7/8	Leiter- quer- schnitt  Wire size  mm <sup>2</sup> AWG	Material	Veredlung			Länge		Steck- dicke  Tab thick- ness  mm	Rast- posi- tion  Inden- tation	Verp.-Einh. Bandform  Packing unit Chain form  x 1000
						blank	Sn	Ni	L 1 mm	L 2 mm			
						Finishing							
						un- plated	Sn	Ni					

Leicht aufsteckbar  
Low insertion force

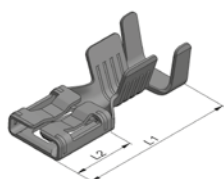

L

<b>RSB 8137 F 6,3-0,5</b>	●	0,22-0,5	CuSn	○	○	○	19,0	7,6	0,8	DIN	8
	●	24-20	CuZn	○	○	○					
	●		Fe			○					
<b>RSB 8136 F 6,3-4</b>		3-5	CuSn	○	○	○	19,0	7,6	0,8	DIN	4,5
		14-10	CuZn	○	○	○					
		*	Fe			●					

\* Doppelcrimp 2 x 1,5 mm<sup>2</sup>  
Double crimp 2 x 2,5 mm<sup>2</sup>  
2 x AWG 14-16

Leicht aufsteckbar  
Low insertion force

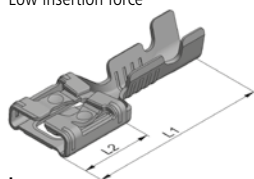

L

<b>RSB 8238.158 F 6,3-1,5</b>	●	0,5-1,5	CuZn	●	●		19,0	7,4	0,8	DIN	8
	●	20-16	Fe			●					
<b>RSB 8238.258 F 6,3-2,5</b>	●	1,5-2,5	CuZn	●	●		19,0	7,4	0,8	DIN	8
	●	16-14	Fe			●					

Leicht aufsteckbar  
Low insertion force

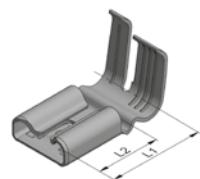

L

<b>RSB 8240.158 F 6,3-1,5</b>		0,5-1,5	CuSn		○		11,5	7,7	0,8	DIN	2
	●	20-16	CuZn	●	●						
	●		Fe			●					
<b>RSB 8240.258 F 6,3-2,5</b>	●	1,5-2,5	CuZn	●	●		11,5	7,7	0,8	DIN	1,8
	●	16-14	Fe			●					
<b>RSB 8240.1158 F 6,3-1,5</b> Für RAST 5 Gehäuse mit externem Rasthaken For RAST 5 housings with external locking		0,5-1,5	CuZn	●	●		11,5	7,7	0,8		2
	●	20-16	Fe			●					
<b>RSB 8240.1258 F 6,3-2,5</b> Für RAST 5 Gehäuse mit externem Rasthaken For RAST 5 housings with external locking		1,5-2,5 16-14	CuZn		○		11,5	7,7	0,8		1,8

Leicht aufsteckbar  
Low insertion force

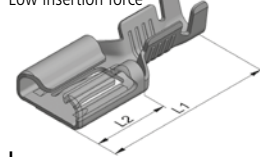

L

<b>RSB 8220.1158 F 6,3-1,5</b> Für Gehäusemontage For housings	●	0,5-1,5 20-16	Fe			●	17,15	7,7	0,8		8
--	---	------------------	----	--	--	---	-------	-----	-----	--	---

● Standard-Artikel / Standard parts ○ lieferbar auf Anfrage / available on request



■ Flachsteckhülsen für Steckbreite 6,3 mm

■ Receptacles for tab width 6,3 mm

Bauform Q = Quertransport L = Längstransport  Supply condition Q = transverse transport / Side feed L = longitudinal transport / End feed	Artikel-Nummer  Part number	Frei- gaben s. Seiten 7/8 Appro- vals s. page 7/8 mm <sup>2</sup> AWG	Leiter- quer- schnitt  Wire size  mm <sup>2</sup> AWG	Material	Veredlung		Länge		Steck- dicke  Tab thick- ness  mm	Rast- posi- tion  Inden- tation	Verp.-Einh. Bandform  Packing unit Chain form  x 1000
					blank	Sn					

Verriegelbar, leicht aufsteckbar  
Self locking, low insertion force

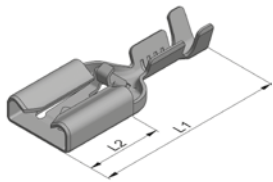

L

<b>RSB 8178.108 F 6,3-1</b> Geeignet für RAST 5 Gehäuse Also for RAST 5 housings	●	0,35-1 22-18	CuZn	●	●	19,2	7,7	0,8	DIN	8
<b>RSB 8178.258 F 6,3-2,5</b> Geeignet für RAST 5 Gehäuse Also for RAST 5 housings	●	1-2,5 16-14	CuZn	●	●	19,2	7,7	0,8	DIN	6,5
<b>RSB 8178.308 F 6,3-3 *</b> Geeignet für RAST 5 Gehäuse Also for RAST 5 housings	●	2x1-2x1,5 2xAWG 18-16	CuZn		●	19,2	7,7	0,8	DIN	4
<b>RSB 8178.1108</b> Für Gehäuse mit externem Rasthaken For housing with external locking		0,35-1 22-18	CuZn		●	19,2	7,7	0,8		8
<b>RSB 8178.1258</b> Für Gehäuse mit externem Rasthaken For housing with external locking		1-2,5 16-14	CuZn		●	19,2	7,7	0,8		6,5

Verriegelbar  
Self locking

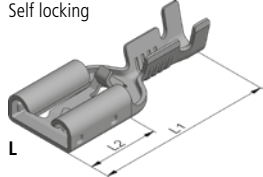

L

<b>RSB 7960.020 F 6.3-1</b>	●	0,5-1	CuSn	○	○	19,3	7,7	0,8	DIN	7
	●	20-18	CuZn	●	●					
	●		CuNiZn	○	○					
<b>RSB 7961.020 F 6.3-2,5</b>	●	1-2,5	CuSn	○	○	19,3	7,7	0,8	DIN	6
	●	16-14	CuZn	●	●					
	●		CuNiZn	○	○					

Verriegelbar  
Self locking

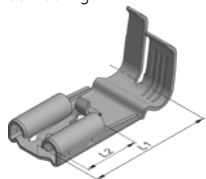

L

<b>RSB 8126.010 F 6,3-1,5</b>	●	0,5-1,5	CuSn	○	○	16,0	7,1	0,8	DIN	1,6
	●	20-16	CuZn	○	○					

Verriegelbar  
Self locking

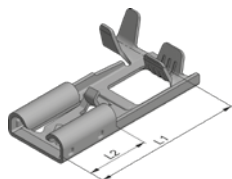

Q

<b>RSB 8047 F 6,3-1</b>	●	0,5-1 20-18	CuZn		○	18,5	7,7	0,8	DIN	4
<b>RSB 8048 F 6,3-2,5</b>		1-2,5 16-14	CuZn		○	18,5	7,7	0,8	DIN	3,5

\* Technisches Datenblatt über verarbeitbare Isolationsdurchmesser auf Anfrage.  
Technical datasheet for available insulation diameters on request.

● Standard-Artikel / Standard parts ○ lieferbar auf Anfrage / available on request

# FLACHSTECKHÜLSEN RECEPTACLES

■ Flachsteckhülsen für Steckbreite 9,5 mm

■ Receptacles for tab width 9,5 mm

Bauform Q = Quertransport L = Längstransport  Supply condition Q = transverse transport / Side feed L = longitudinal transport / End feed	Artikel-Nummer  Part number	DIN	Freigabens. Seiten 7/8 Approvals s. page 7/8	Leiterquerschnitt  Wire size  mm <sup>2</sup> AWG	Material	Veredlung			Länge		Steckdicke  Tab thickness  mm	Rastposition  Indentation	Verp.-Einh. Bandform  Packing unit Chain form  x 1000
						blank	Sn	Ni	Length				
						un-plated	Sn	Ni	L 1 mm	L 2 mm			

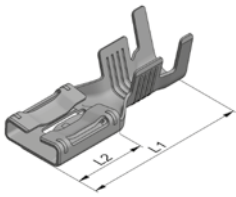

L

<b>RSB 8271.112 F 9,5-10</b>				6-10	CuSn	○	○	27	12	1,2	IEC	2,5
				10-8	CuZn	○	○					
					CuNiZnSi		●					

● Standard-Artikel / Standard parts    ○ lieferbar auf Anfrage / available on request

■ Flachstecker mit Steckbreite 2,8 mm

■ Tabs width 2,8 mm

Bauform Q = Quertransport L = Längstransport  Supply condition Q = transverse transport / Side feed L = longitudinal transport / End feed	Artikel-Nummer  Part number	DIN	Freigabens. Seiten 7/8 Approvals s. page 7/8	Leiterquer-schnitt  Wire size mm <sup>2</sup>  AWG	Material	Veredlung			Länge		Steckbreite  Tab width mm	Steckdicke  Tab thick-ness mm	Rast-posit-ion  Inden-tation	Verp.-Einh. Bandform  Packing unit Chain form  x 1000
						blank	Sn	Ni	L 1 mm	L 2 mm				
						Finishing								
						un-plated	Sn	Ni						

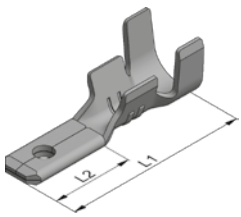

L

<b>RMB 7958 F 2,8-1</b>			●	0,5-1 20-18	CuZn		●		12,6	5,5	2,8	0,8	●	15
-------------------------	--	--	---	----------------	------	--	---	--	------	-----	-----	-----	---	----

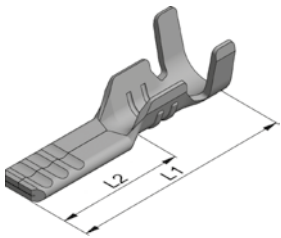

L

<b>RMB 7930 V 2,8-1</b>				0,5-1 20-18	CuZn	●	○		13,1	6,7	2,8	0,8	ohne without	18
-------------------------	--	--	--	----------------	------	---	---	--	------	-----	-----	-----	-----------------	----

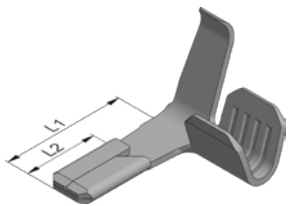

L

<b>RMB 8205.1158 Z 2,8-1,5</b>				0,75-1,5 18-14	CuZn		●		8,0	4,75	2,8	0,8	ohne without	6
--------------------------------	--	--	--	-------------------	------	--	---	--	-----	------	-----	-----	-----------------	---

● Standard-Artikel / Standard parts    ○ lieferbar auf Anfrage / available on request

# FLACHSTECKER TABS

■ Flachstecker mit Steckbreite 4,8 mm

■ Tabs width 4,8 mm

Bauform Q = Quertransport L = Längstransport  Supply condition Q = transverse transport / Side feed L = longitudinal transport / End feed	Artikel-Nummer  Part number	DIN	Freigabens. Seiten 7/8 Approvals s. page 7/8	Leiterquer-schnitt  Wire size mm <sup>2</sup>  AWG	Material	Veredlung			Länge		Steckbreite  Tab width mm	Steckdicke  Tab thick-ness mm	Rast-position  Inden-tation	Verp.-Einh. Bandform  Packing unit Chainform  x 1000
						blank	Sn	Ni	L 1 mm	L 2 mm				
						Finishing								
						un-plated								

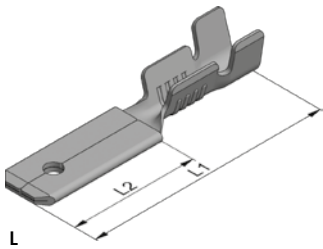

L

<b>RMB 8165.108 Z 4,8-1</b>			●	0,5-1,5 20-16	CuZn	●	●		21,7	11,4	4,8	0,8	●	8
-----------------------------	--	--	---	------------------	------	---	---	--	------	------	-----	-----	---	---

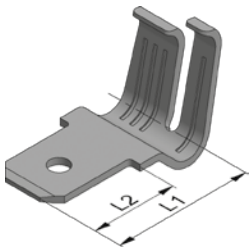

L

<b>RMB 8043 Z 4,8-1</b>				0,5-1 20-18	CuZn Fe	●			10,2	6,3	4,8	0,5	●	4
-------------------------	--	--	--	----------------	------------	---	--	--	------	-----	-----	-----	---	---

● Standard-Artikel / Standard parts    ○ lieferbar auf Anfrage / available on request

■ Flachstecker mit Steckbreite 6,3 mm

■ Tabs width 6,3 mm

Bauform Q = Quertransport L = Längstransport  Supply condition Q = transverse transport / Side feed L = longitudinal transport / End feed	Artikel-Nummer  Part number	DIN	Frei- gaben- s. Seiten 7/8  Appro- vals s. page 7/8  AWG	Leiter- quer- schnitt  Wire size mm <sup>2</sup>	Material	Veredlung			Länge		Steck- breite  Tab width mm	Steck- dicke  Tab thick- ness mm	Rast- posi- tion  Inden- tation	Verp.-Einh.	
						blank	Sn	Ni	L 1 mm	L 2 mm				Chain form	loose piece
						un- plated	Sn	Ni							

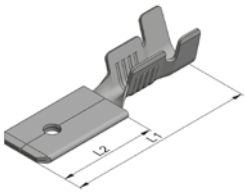

L

<b>RMB 7840 Z 6,3-1</b>				0,5-1,5 20-16	CuZn		●		21,7	11,4	6,3	0,8	DIN	8	
-------------------------	--	--	--	------------------	------	--	---	--	------	------	-----	-----	-----	---	--

Für Gehäuse  
For housings

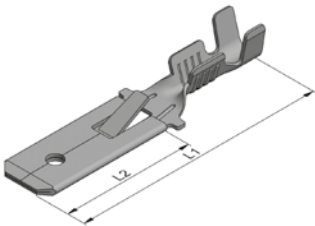

L

<b>RMB 7831.010 Z 6,3-1</b>	46343 T 3 B 6,3-1	●	0,5-1,5 20-16	CuSn CuZn	●	●		28,0	15,5	6,3	0,8	DIN	5,5	
<b>RMB 7833.010 Z 6,3-2,5</b>	46343 T 3 B 6,3-2,5	●	1-2,5 16-14	CuZn	●	●		28,0	15,5	6,3	0,8	DIN	4,5	

● Standard-Artikel / Standard parts    ○ lieferbar auf Anfrage / available on request

# LEITERPLATTEN-KONTAKTE PRINTED BOARDS CONTACTS

- Flachstecker für Leiterplatten,  
Steckbreite 2,8 - 4,8 mm

- Tabs for printed circuits,  
width 2,8 - 4,8 mm

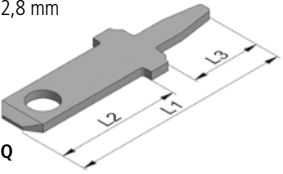
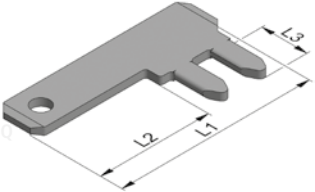
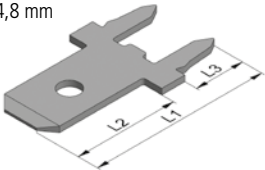
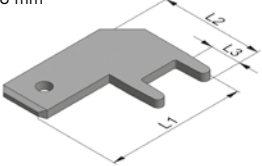
Bauform Q = Quertransport L = Längstransport  Supply condition Q = transverse transport / Side feed L = longitudinal transport / End feed	Artikel-Nummer  Part number	Material	Veredlung			Länge			Steck- dicke  Tab thick- ness  mm	Steck- breite  Tab width  mm	Rast- loch  Inden- tation	Verp.-Einh.	
			blank	Sn	Ni	L 1 mm	L 2 mm	L 3 mm				Band- form	lose piece
			Finishing										
			un- plated	Sn	Ni								
												Packing unit	
												Chain form	loose piece
												x 1000	
2,8 mm 	<b>RMB 5920.004 P 1,4-2,8</b>	CuZn		●		13,2	7,5	4,1	0,8	2,8	●	20	40
2,8 mm 	<b>RMB 6199</b>	CuZn		●		12,5	min. 7	3	0,5	2,8	●	12	
4,8 mm 	<b>RMB 6008 P 1,3-4,8</b>	CuZn		●		14,0	8,0	4,0	0,8	4,8	●	15	20
	<b>RMB 6008.001 P 1,3-4,8</b>	CuZn		○		14,0	8,0	4,0	0,5	4,8	●	15	20
	<b>RMB 6008.002 P 1,3-4,8</b>	CuSn CuZn		○ ○		14,0	8,0	4,0	0,8	4,8	DIN	15	20
4,8 mm 	<b>RM 6045 P 1,2-4,8</b>	CuZn		○		13,5	10,0	3,0	0,8	4,8	●		15

● Standard-Artikel / Standard parts   ○ lieferbar auf Anfrage / available on request

- Flachstecker für Leiterplatten,  
Steckbreite 6,3 mm

- Tabs for printed circuits,  
width 6,3 mm

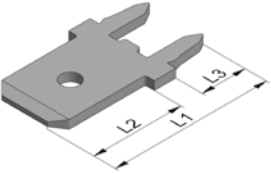
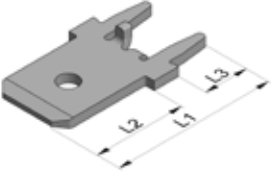
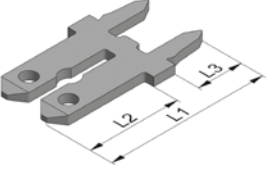
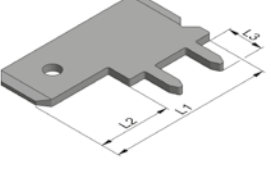
Bauform Q = Quertransport L = Längstransport  Supply condition Q = transverse transport / Side feed L = longitudinal transport / End feed	Artikel-Nummer  Part number	Material	Veredlung			Abmessungen			Steck- dicke  Tab thick- ness  mm	Steck- breite  Tab width  mm	Rastloch  Inden- tation	Verp.-Einh.	
			blank	Sn	Ni	L 1 mm	L 2 mm	L 3 mm				Chain form	loose piece
			Finishing										
			un- plated	Sn	Ni								
												Packing unit	
												x 1000	
	<b>RMB 6006 P 1,3-6,3</b>	CuZn		●		14,0	8,0	4,0	0,8	6,3	DIN	15	20
	<b>RMB 6006.002 P 1,3-6,3</b> Für Gehäuse For housing	CuZn		●		16,0	10,0	4,0	0,8	6,3	DIN	15	20
	<b>RMB 6006.100 P 1,3-6,3</b>	CuZn		●	selectiv selective	14,0	8,0	4,0	0,8	6,3	DIN	15	
	<b>RM 6006.005 P 1,3-6,3</b> Stabilisator Laschen Stabilizer tabs	CuZn		●		14,4	8,0	4,0	0,8	6,3	IEC		20
	<b>RMB 6007.002 P 1,3-6,3</b>	CuZn	○	○		14,0	8,0	4,0	0,8	6,3	DIN	15	20
	<b>RMB 6201 P 1,2-6,3</b>	CuZn	○	●		18,0	8,0	4,0	0,8	6,3	DIN	10	10

● Standard-Artikel / Standard parts    ○ lieferbar auf Anfrage / available on request



# FLACHSTECKER TABS

- Flachstecker zum Anschweißen,  
Steckbreite 6,3 mm

- Weld tabs  
width 6,3 mm

Bauform Q = Quertransport L = Längstransport  Supply condition Q = transverse transport / Side feed L = longitudinal transport / End feed	Artikel-Nummer  Part number	Material	Veredlung			Abmessungen			Steck- dicke  Tab thick- ness  mm	Win- kel  Angle  °	Rastloch  Inden- tation	Verp.-Einh.	
			blank	Sn	Ni	L 1 mm	L 2 mm	L 3 mm				Band- form	lose piece
			Finishing										
			un- plated	Sn	Ni								
											Chain form	loose piece	
											x 1000		

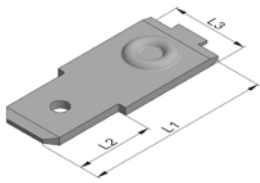

L

<b>RMB 7942 VS-6,3</b>	Fe				●	19,0	8,0	8,0	0,8	0°	DIN	9	
------------------------	----	--	--	--	---	------	-----	-----	-----	----	-----	---	--

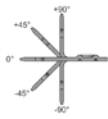
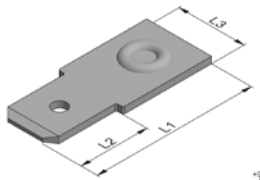

<b>RM 6015 VS 6,3</b>	Fe				○	19,0	8,0	8,0	0,8	0°	DIN		13
<b>RM 6015.645 VS 6,3</b>	Fe				○	19,0	8,0	8,0	0,8	+45°	DIN		13
<b>RM 6015.845 VS 6,3</b>	Fe				○	19,0	8,0	8,0	0,8	-45°	DIN		13
<b>RM 6015.290 VS 6,3</b>	Fe				○	19,0	8,0	8,0	0,8	+90°	DIN		13
<b>RM 6015.690 VS 6,3</b>	Fe				○	19,0	8,0	8,0	0,8	-90°	DIN		13

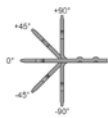
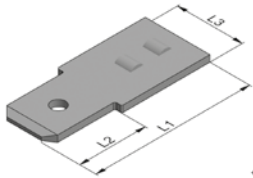

<b>RM 6015.001 VS 6,3</b>	Fe				○	19,0	8,0	8,0	0,8	0°	DIN		13
<b>RM 6015.345 VS 6,3</b>	Fe				○	19,0	8,0	8,0	0,8	+45°	DIN		13
<b>RM 6015.245 VS 6,3</b>	Fe				○	19,0	8,0	8,0	0,8	-45°	DIN		13
<b>RM 6015.890 VS 6,3</b>	Fe				○	19,0	8,0	8,0	0,8	+90°	DIN		13
<b>RM 6015.490 VS 6,3</b>	Fe				○	19,0	8,0	8,0	0,8	-90°	DIN		13

● Standard-Artikel / Standard parts    ○ lieferbar auf Anfrage / available on request

- Flachstecker zum Anschweißen,  
Steckbreite 6,3 mm

- Weld tabs  
width 6,3 mm

Bauform Q = Quertransport L = Längstransport  Supply condition Q = transverse transport / Side feed L = longitudinal transport / End feed	Artikel-Nummer  Part number	Material	Veredlung			Abmessungen			Steck- dicke  Tab thick- ness  mm	Winkel  Angle  °	Rastloch  Inden- tation	Verp.-Einh. lose  Packing unit loose piece  x 1000
			blank	Sn	Ni	L 1 mm	L 2 mm	L 3 mm				
			Finishing									
			un- plated	Sn	Ni							

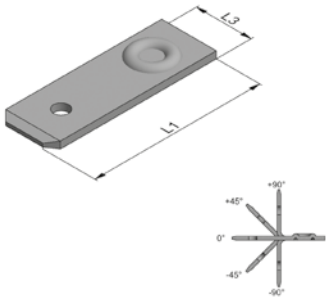

<b>RM 6015.003 VS 6,3</b>	Fe			○	19,0	6,3	0,8	0°	DIN	13
<b>RM 6015.545 VS 6,3</b>	Fe			○	19,0	6,3	0,8	+45°	DIN	13
<b>RM 6015.745 VS 6,3</b>	Fe			○	19,0	6,3	0,8	-45°	DIN	13
<b>RM 6015.190 VS 6,3</b>	Fe			○	19,0	6,3	0,8	+90°	DIN	13
<b>RM 6015.390 VS 6,3</b>	Fe			○	19,0	6,3	0,8	-90°	DIN	13

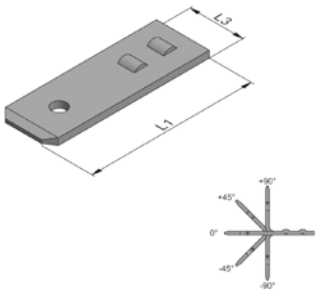

<b>RM 6015.002 VS 6,3</b>	Fe			○	19,0	6,3	0,8	0°	DIN	13
<b>RM 6015.445 VS 6,3</b>	Fe			○	19,0	6,3	0,8	+45°	DIN	13
<b>RM 6015.145 VS 6,3</b>	Fe			○	19,0	6,3	0,8	-45°	DIN	13
<b>RM 6015.790 VS 6,3</b>	Fe			○	19,0	6,3	0,8	+90°	DIN	13
<b>RM 6015.590 VS 6,3</b>	Fe			○	19,0	6,3	0,8	-90°	DIN	13

● Standard-Artikel / Standard parts    ○ lieferbar auf Anfrage / available on request

- Flachstecker zum Befestigen und Anschweißen,  
Steckbreite 4,8 mm

- Tabs for fixing and welding,  
width 4,8 mm

Bauform Q = Quertransport L = Längstransport  Supply condition Q = transverse transport / Side feed L = longitudinal transport / End feed	Artikel-Nummer  Part number	Material	Veredlung			Abmessungen			Bohrungs Ø	Steck- dicke	Win- kel	Rast- loch	Verp.-Einh. lose
			blank	Sn	Ni	Dimensions							
			un- plated	Sn	Ni	L 1 mm	L 2 mm	L 3 mm					

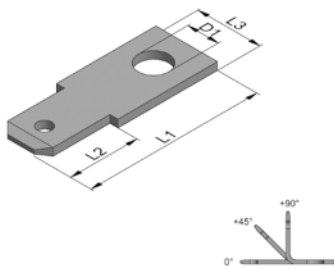

<b>RM 6080 A 3-4,8</b>	CuZn	○	○		17,5	7,2	6,5	3,2	0,8	0°	DIN	20
<b>RM 6080 A 4-4,8</b>	Fe			○	17,5	7,2	6,5	4,3	0,8	0°	DIN	20
<b>RM 6080.045 A 3-4,8</b>	CuZn Fe	○	○	○	17,5	7,2	6,5	3,2	0,8	45°	DIN	20
<b>RM 6080.090 A 3-4,8</b>	CuZn		○		17,5	7,2	6,5	3,2	0,8	90°	DIN	20

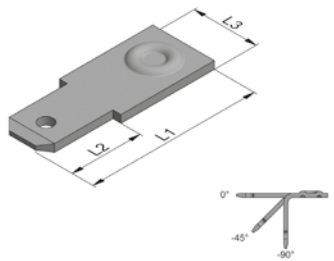

<b>RM 6059 VS 4,8</b>	Fe			○	17,0	7,4	6,5		0,8	0°		20
<b>RM 6059.645 VS 4,8</b>	Fe			○	17,0	7,4	6,5		0,8	-45°		20
<b>RM 6059.690 VS 4,8</b>	Fe			○	17,0	7,4	6,5		0,8	-90°		20

- Standard-Artikel / Standard parts    ○ lieferbar auf Anfrage / available on request

- Flachstecker zum Befestigen,  
Steckbreite 6,3 mm

- Tabs for fixing,  
width 6,3 mm

Bauform Q = Quertransport L = Längstransport  Supply condition Q = transverse transport / Side feed L = longitudinal transport / End feed	Artikel-Nummer  Part number	Material	Veredlung			Abmessungen			Bohrungs- Ø	Steck- dicke	Win- kel	Rast- loch	Verp.-Einh. lose
			blank	Sn	Ni	Dimensions							
			un- plated			L 1 mm	L 2 mm	L 3 mm					

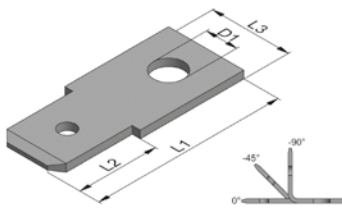

<b>RM 6015 A 3-6,3</b>	CuZn	○	●		19,0	8,1	8,0	3,2	0,8	0°	DIN	13
	Fe			○								
<b>RM 6015 A 4-6,3</b>	CuZn	○	●		19,0	8,1	8,0	4,3	0,8	0°	DIN	13
	Fe			○								
<b>RM 6015 A 5-6,3</b>	CuZn	○	○		19,0	8,1	8,0	5,3	0,8	0°	DIN	13
	Fe			○								
<b>RM 6015.045 A 3-6,3</b>	CuZn	○	○		19,0	8,1	8,0	3,2	0,8	45°	DIN	13
	Fe			○								
<b>RM 6015.045 A 4-6,3</b>	CuZn	●	○		19,0	8,1	8,0	4,3	0,8	45°	DIN	13
	Fe			●								
<b>RM 6015.045 A 5-6,3</b>	CuZn	●	●		19,0	8,1	8,0	5,3	0,8	45°	DIN	13
	Fe			○								
<b>RM 6015.045 A 6-6,3</b>	CuZn	●	●		19,0	8,1	8,0	6,3	0,8	45°	DIN	13
	Fe			○								
<b>RM 6015.090 A 3-6,3</b>	CuZn	○	○		19,0	8,1	8,0	3,2	0,8	90°	DIN	13
	Fe			○								
<b>RM 6015.090 A 3,5-6,3</b>	CuZn	○	○		19,0	8,1	8,0	3,7	0,8	90°	DIN	13
	Fe			○								
<b>RM 6015.090 A 4-6,3</b>	CuZn	○	○		19,0	8,1	8,0	4,3	0,8	90°	DIN	13
	Fe			○								
<b>RM 6015.090 A 5-6,3</b>	CuZn	○	○		19,0	8,1	8,0	5,3	0,8	90°	DIN	13
	Fe											

● Standard-Artikel / Standard parts    ○ lieferbar auf Anfrage / available on request

- Flachstecker zum Befestigen,  
Steckbreite 6,3 mm

- Tabs for fixing,  
width 6,3 mm

Bauform Q = Quertransport L = Längstransport  Supply condition Q = transverse transport / Side feed L = longitudinal transport / End feed	Artikel-Nummer  Part number	Material	Veredlung			Abmessungen			Bohrungs- Ø  Drill hole Ø D 1 mm	Steck- dicke  Tab thick- ness  mm	Win- kel  Angle  °	Rast- loch  Inden- tation	Verp.-Einh. lose  Packing unit loose piece  x 1000
			blank	Sn	Ni	L 1 mm	L 2 mm	L 3 mm					
			un- plated										

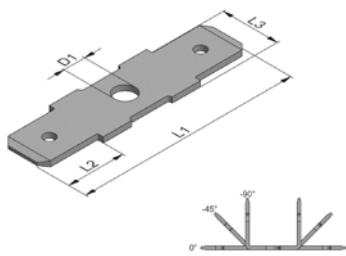

<b>RM 6129 DSL 3-6,3</b>	CuZn	○	○		30,0	8,1	8,0	3,1	0,8	0°	DIN	10
<b>RM 6129 A 4-6,3</b>	CuZn	○	○		30,0	8,1	8,0	4,3	0,8	0°	DIN	10
<b>RM 6129 A 5-6,3</b>	CuZn	○	○		30,0	8,1	8,0	5,3	0,8	0°	DIN	10
<b>RM 6129.045 DSL 3-6,3</b>	CuZn	○	○		30,0	8,1	8,0	3,1	0,8	45°	DIN	8
<b>RM 6129.045 A 4-6,3</b>	CuZn	○	○		30,0	8,1	8,0	4,3	0,8	45°	DIN	8
<b>RM 6129.045 A 5-6,3</b>	CuZn	○	○		30,0	8,1	8,0	5,3	0,8	45°	DIN	8
<b>RM 6129.090 DSL 3-6,3</b>	CuZn	○	○		30,0	8,1	8,0	3,1	0,8	90°	DIN	6
<b>RM 6129.090 A 4-6,3</b>	CuZn	○	○		30,0	8,1	8,0	4,3	0,8	90°	DIN	6
<b>RM 6129.090 A 5-6,3</b>	CuZn	○	○		30,0	8,1	8,0	5,3	0,8	90°	DIN	6

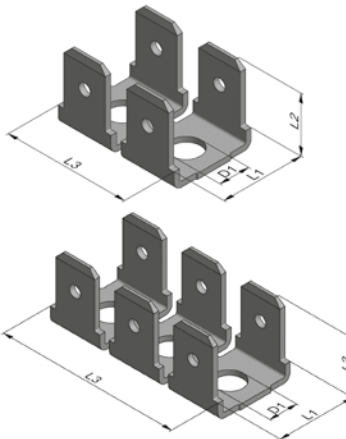

<b>RM 6129/2 A 4-6,3</b>	CuZn	○	○		11,6	8,1	17,5	4,3	0,8	0°	DIN	5
<b>RM 6129.075/2 A 4-6,3</b>	CuZn	○	○		11,6	8,1	17,5	4,3	0,8	75°	DIN	2
<b>RM 6129.090/2 A 4-6,3</b>	CuZn	○	○		11,6	8,1	17,5	4,3	0,8	90°	DIN	2
<b>RM 6129.045/3 DSL 3-6,3</b>	CuZn	○	○		11,6	8,1	27,0	3,0	0,8	45°	DIN	1,3
<b>RM 6129.090/3 A 4-6,3</b>	CuZn	○	○		11,6	8,1	27,0	4,3	0,8	90°	DIN	1,3

- Standard-Artikel / Standard parts
- lieferbar auf Anfrage / available on request

■ Krallenkabelschuhe ohne Isolationscrimp

■ Open barrel terminals without insulation crimp

Bauform Q = Quertransport L = Längstransport  Supply condition Q = transverse transport / Side feed L = longitudinal transport / End feed	Artikel-Nummer	Leiter- quer- schnitt	Material	Veredlung			Außen Ø	Bohrungs- Ø	Länge	Material- stärke	Verp.-Einh. Bandform
	Part number	Wire size	Material	Finishing			Outside Ø	Drill hole Ø	Length	Material thickness	Packing unit Chain form
				un- plated	Sn	Ni					
				mm <sup>2</sup> AWG					d 3 mm	d 2 mm	L mm

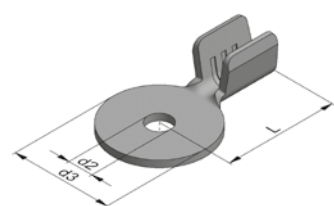

L

<b>RSB 7727 A 1,7-1</b>	0,5-1	CuZn	○	●		6,8	1,70	7,6	0,5	20
	20-18	Fe			○					
<b>RSB 7727 A 2,6-1</b>	0,5-1	CuZn	○	○		6,8	2,80	7,6	0,5	20
	20-18	Fe			○					
<b>RSB 7727 A 3-1</b>	0,5-1	CuZn	○	○		6,8	3,20	7,6	0,5	20
	20-18	Fe			○					
<b>RSB 7727 A 3,5-1</b>	0,5-1	CuZn	○	○		6,8	3,70	7,6	0,5	20
	20-18	Fe			○					
<b>RSB 7727 A 4-1</b>	0,5-1	CuZn	●	●		6,8	4,30	7,6	0,5	20
	20-18	Fe			○					

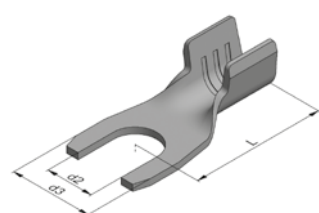

L

<b>RSB 7779 C 5-6</b>	4-4 12-10	CuZn	●	○		9,5	5,50	15,5	0,8	4,5
<b>RSB 7779 C 5-10</b>	6-10 10-7	CuZn	●	○		9,3	5,50	15,5	1,0	2
<b>RSB 7779 C 6-10</b>	6-10 10-7	CuZn	●	○		9,3	6,20	15,5	1,0	2

● Standard-Artikel / Standard parts    ○ lieferbar auf Anfrage / available on request

# KRALLENKABELSCHUHE OPEN BARREL TERMINALS

■ Krallenkabelschuhe mit Isolationscrimp

■ Open barrel terminals with insulation crimp

Bauform Q = Quertransport L = Längstransport  Supply condition Q = transverse transport / Side feed L = longitudinal transport / End feed	Artikel-Nummer	DIN	UL-Freigaben s. Seiten 7/8 Approvals s. page 7/8	Leiterquer- schnitt  Wire size  mm <sup>2</sup> AWG	Material	Veredlung			Außen Ø	Bohrungs- Ø	Länge	Material- stärke	Verp.-Einh. Bandform					
	Part number					blank	Sn	Ni						Outside Ø	Drill hole Ø	Length	Material thickness	Packing unit Chain form
						un- plated	Sn	Ni										

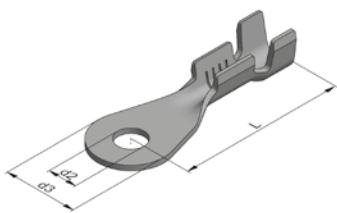

L

<b>RSB 7813 A 3-0,5</b>				0,13-0,5 26-20	CuZn	○	●		5,0	3,2	8,5	0,3	22
<b>RSB 7716.001 A 3-1</b>				0,5-1 20-18	CuZn Fe	●	●		6,3	3,2	8,8	0,5	14
<b>RSB 7716.001 A 3,5-1</b>				0,5-1 20-18	CuZn Fe	●	●		6,3	3,7	8,8	0,5	14
<b>RSB 7716.001 A 4-1</b>				0,5-1 20-18	CuZn Fe	●	●		6,3	4,3	8,8	0,5	14
<b>RSB 7206 A 3-1</b>	46225 A 3-1			0,35-1 22-18	CuSn CuZn Fe	○	○		8,0	3,2	18,0	0,6	6
<b>RSB 7206 A 3,5-1</b>				0,35-1 22-18	CuSn CuZn Fe	○	○		8,0	3,7	18,0	0,6	6
<b>RSB 7206 A 4-1</b>	46225 A 4-1			0,35-1 22-18	CuSn CuZn Fe	○	○		8,0	4,3	18,0	0,6	6
<b>RSB 7207 A 5-1</b>	46225 A 5-1			0,35-1 24-18	CuSn CuZn Fe	○	○		9,5	5,3	17,0	0,6	6
<b>RSB 8202 A 6-1</b>	46225 A 6-1			0,5-1 20-18	CuSn CuZn	○	●		12,0	6,5	22,0	0,6	5
<b>RSB 8202.108 A 8-1</b>	46225 A 8-1			0,5-1 20-18	CuSn CuZn	○	○		14,0	8,4	21,0	0,6	5
<b>RSB 7881 A 3-1,5</b>				0,5-1,5 18-16	CuZn	○	○		8,8	3,2	12,7	0,5	6
<b>RSB 7881 A 3,5-1,5</b>				0,5-1,5 18-16	CuZn	●	○		8,8	3,7	12,7	0,5	6
<b>RSB 7881 A 4-1,5</b>				0,5-1,5 18-16	CuZn	●	○		8,8	4,3	12,7	0,5	6
<b>RSB 7881 A 5-1,5</b>				0,5-1,5 18-16	CuZn	○	○		8,8	5,3	12,7	0,5	6
<b>RSB 7881 A 6-1,5</b>				0,5-1,5 18-16	CuZn	●	●		8,8	6,5	12,7	0,5	6

● Standard-Artikel / Standard parts ○ lieferbar auf Anfrage / available on request



■ Krallenkabelschuhe mit Isolationscrimp

■ Open barrel terminals with insulation crimp

Bauform Q = Quertransport L = Längstransport  Supply condition Q = transverse transport / Side feed L = longitudinal transport / End feed	Artikel-Nummer	DIN UL	Leiterquer- schnitt	Material	Veredlung			Außen Ø	Bohrungs- Ø	Länge	Material- stärke	Verp.-Einh. Bandform
	Part number	Wire size	Material	Finishing			Outside Ø	Drill hole Ø	Length	Material thickness	Packing unit Chain form	
				blank	Sn	Ni						
			mm <sup>2</sup> AWG		un- plated			d 3 mm	d 2 mm	L mm	mm	x 1000

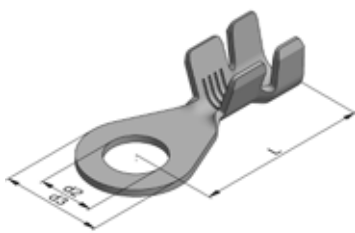

L

\* ähnlich / similar to DIN 46225 A 6-2,5

\*\* ähnlich / similar to DIN 46225 A 8-2,5

<b>RSB 8203 A 6-2,5</b>	*	1-2,5	CuSn	○	●		12,0	6,5	22,0	0,6	5,5
		16-14	CuZn	○	○						
<b>RSB 8204 A 8-2,5</b>	**	1-2,5	CuSn	○	●		14,0	8,4	21,0	0,6	4,8
		16-14									
<b>RSB 7208 A 3-2,5</b>	46225 A 3-2,5	1,5-2,5	CuSn	○	○		8,0	3,2	18,0	0,6	5
		16-14	CuZn	○	○						
			Fe			○					
<b>RSB 7208 A 4-2,5</b>	46225 A 4-2,5	1,5-2,5	CuSn	○	○		8,0	4,3	18,0	0,6	5
		16-14	CuZn	●	●						
			Fe			●					
<b>RSB 7209 A 5-2,5</b>	46225 A 5-2,5	1,5-2,5	CuSn	○	○		9,5	5,3	17,0	0,6	5
		16-14	CuZn	●	●						
			Fe			○					
<b>RSB 7209 A 6-2,5</b>		1,5-2,5	CuSn	○	○		9,5	6,5	17,0	0,6	5
		16-14	CuZn	○	●						
			Fe			○					
<b>RSB 7877 A 3-4</b>		1-2,5 16-14	CuZn	○	○		8,7	3,2	15,4	0,8	5
<b>RSB 7877 A 3,5-4</b>		1-2,5 16-14	CuZn	○	○		8,7	3,7	15,4	0,8	5
<b>RSB 7877 A 4-4</b>		1-2,5 16-14	CuZn	●	●		8,7	4,3	15,4	0,8	5
<b>RSB 7877 A 5-4</b>		1-2,5 16-14	CuZn	○	○		8,7	5,3	15,4	0,8	5
<b>RSB 7788 A 4-6</b>	●	4-6	CuSn	○	○		11,8	4,3	20,0	0,8	3
	●	12-10	CuZn	○	●						
<b>RSB 7788 A 5-6</b>	●	4-6	CuSn	○	○		11,8	5,3	20,0	0,8	3
	●	12-10	CuZn	○	●						
<b>RSB 7788 A 6-6</b>	●	4-6	CuSn	○	○		11,8	6,4	20,0	0,8	3
	●	12-10	CuZn	○	●						
<b>RSB 7788 A 8-6</b>	●	4-6	CuSn	○	○		11,8	8,4	20,0	0,8	3
	●	12-10	CuZn	○	●						
<b>RSB 8201 A 6-6</b>	46225 A 6-6	2,5-6	CuSn	○	●		12,0	6,5	25,0	0,8	3
		12-10	CuZn	○	○						
<b>RSB 8200 A 6-10</b>	46225 A 6-10	6-10	CuSn	○	●		12,0	6,5	23,0	1,0	2
		10-8	CuZn	○	○						

● Standard-Artikel / Standard parts ○ lieferbar auf Anfrage / available on request

# KRALLENKABELSCHUHE OPEN BARREL TERMINALS

- Krallenkabelschuhe mit Isolationscrimp
- Krallenkabelschuhe Sonderausführungen
- Open barrel terminals with insulation crimp
- Open barrel terminals special types

Bauform Q = Quertransport L = Längstransport	Artikel-Nummer	DIN UL	Leiterquer- schnitt	Material	Veredlung			Außen Ø	Bohrungs- Ø	Länge	Material- stärke	Verp.-Einh. Bandform
					blank	Sn	Ni					
					Finishing							
Supply condition Q = transverse transport / Side feed L = longitudinal transport / End feed	Part number		Wire size	Material	un- plated	Sn	Ni	d 3 mm	d 2 mm	L mm	mm	x 1000

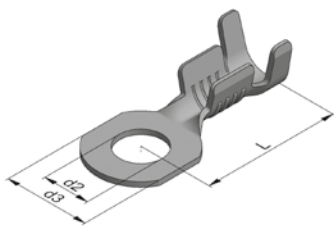

<b>RSB 7716.002 A 2,7-1</b>			0,5-1 20-18	CuZn Fe	○	○		4,5	2,7	8,8	0,5	16
<b>RSB 7881.001 A 3-1,5</b>			0,5-1,5 18-16	CuZn	○	○		7,8	3,2	12,7	0,5	6
<b>RSB 7881.001 A 3,5-1,5</b>			0,5-1,5 18-16	CuZn	○	○		7,8	3,7	12,7	0,5	6
<b>RSB 7881.001 A 4-1,5</b>			0,5-1,5 18-16	CuZn	●	●		7,8	4,3	12,7	0,5	6
<b>RSB 7788.001 A 4-6</b>			4-6 12-10	CuZn	○	○		9,0	4,3	20,0	0,8	3
<b>RSB 7788.001 A 5-6</b>			4-6 12-10	CuZn	○	●		9,0	5,3	20,0	0,8	3
<b>RSB 7788.001 A 6-6</b>			4-6 12-10	CuZn	○	○		9,0	6,4	20,0	0,8	3

L

Sonderausführungen  
Special types

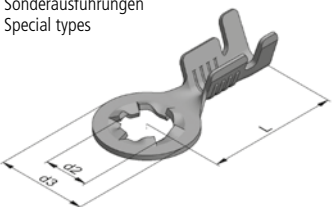

<b>RSB 8134.010 V 4-1,5</b>			0,5-1,5 20-16	Fe		●	○	8,8	4,3	12,7	0,5	6
<b>RSB 7923.002 V 3,5-1</b>	●	0,35-1	CuSn	○	○			8,8	3,8	15,4	0,6	7
	●	22-18	CuZn	○	○							
	●		Fe			○						
<b>RSB 7923.002 V 5-1</b>	●	0,35-1	CuSn	○	○			8,8	5,2	15,4	0,6	7
	●	22-18	CuZn	○	○							
	●		Fe			●						

L

● Standard-Artikel / Standard parts ○ lieferbar auf Anfrage / available on request

■ Krallenkabelschuhe C-Form

■ Open barrel terminals C-Type

Bauform Q = Quertransport L = Längstransport	Artikel-Nummer	DIN	Leiterquer- schnitt	Material	Veredlung			Außen Ø	Bohrungs- Ø	Länge	Material- stärke	Verp.-Einh. Bandform
					blank	Sn	Ni					
					Finishing							
Supply condition Q = transverse transport / Side feed L = longitudinal transport / End feed	Part number		Wire size	Material	un- plated	Sn	Ni	d 3 mm	d 2 mm	L mm	mm	x 1000
			mm <sup>2</sup> AWG									

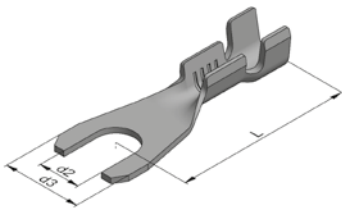

L

<b>RSB 7738 C 3-1</b>			0,5-1 20-18	CuZn	●	●		5,9	3,20	9,0	0,5	12
<b>RSB 7830 C 3-1</b>			0,5-1 20-18	CuZn	○	○		8,0	3,20	18,0	0,6	5
<b>RSB 7830.001 C 3-1</b>			0,5-1 20-18	CuZn	○	○		6,8	3,20	18,0	0,6	5
<b>RSB 7830.001 C 3,5-1</b>			0,5-1 20-18	CuZn	○	●		6,8	3,70	18,0	0,6	5
<b>RSB 7830 C 4-1</b>			0,5-1 20-18	CuZn	●	○		8,0	4,30	18,0	0,6	5
<b>RSB 7830.001 C 4-1</b>			0,5-1 20-18	CuZn	○	○		6,8	4,30	18,0	0,6	5
<b>RSB 7830 C 5-1</b>			0,5-1 20-18	CuZn	○	○		8,0	5,30	17,5	0,6	5
<b>RSB 7843 C 3-2,5</b>			1-2,5 16-14	CuZn	○	○		8,0	3,20	18,0	0,6	5
<b>RSB 7843.001 C 3-2,5</b>			1-2,5 16-14	CuZn	○	○		6,8	3,20	18,0	0,6	5
<b>RSB 7843 C 3,5-2,5</b>			1-2,5 16-14	CuZn	○	○		8,0	3,70	18,0	0,6	5
<b>RSB 7843.001 C 3,5-2,5</b>			1-2,5 16-14	CuZn	○	○		6,8	3,70	18,0	0,6	5
<b>RSB 7843.001 C 4-2,5</b>			1-2,5 16-14	CuZn	○	●		6,8	4,30	18,0	0,6	5
<b>RSB 7843 C 4-2,5</b>		46225 B 4-2,5	1-2,5 16-14	CuZn	●	●		8,0	4,30	18,0	0,6	5
<b>RSB 7843 C 5-2,5</b>			1-2,5 16-14	CuZn	●	○		8,0	5,30	17,5	0,6	5

● Standard-Artikel / Standard parts    ○ lieferbar auf Anfrage / available on request

# ADERENDHÜLSEN END SPLICES

Bauform Q = Quertransport L = Längstransport  Supply condition Q = transverse transport / Side feed L = longitudinal transport / End feed	Artikel-Nummer	Freigabe s. Seite 7/8	Leiterquer- schnitt	Material	Veredlung			Länge	Material- stärke	Verp.-Einh. Bandform
	Part number	Approvals s. page 7/8	Wire size  mm <sup>2</sup> AWG	Material	Finishing			Length  L 2 mm	Material thickness  mm	Packing unit Chain form  x 1000
					blank	Sn	Ni			
 L	RSB 7838 V-0,75		0,25-0,75	CuZn	○	●		3,7	0,3	99
			24-20	Z 8 C 17	○					
 L	RSB 7792.002 V-1,5		● 0,75-1,5	CuZn	●	●		6,0	0,3	40
			● 18-14	Fe			●			
 Q	RSB 7825.001 V-1		0,5-1,5	CuZn	●	○		5,8	0,3	16
	RSB 8059 V-2,5		1,5-2,5 16-14	CuZn Fe	○	○		6,4	0,4	6
 Q	RSB 8236		0,5-1	CuZn	●	○		4,0	0,3	26

● Standard-Artikel / Standard parts ○ lieferbar auf Anfrage / available on request

Bauform Q = Quertransport L = Längstransport  Supply condition Q = transverse transport / Side feed L = longitudinal transport / End feed	Artikel-Nummer	DIN	UL	Leiterquer- schnitt	Material	Veredlung			Länge	Material- stärke	Verp.-Einh. Bandform
	Part number	DIN	UL	Wire size	Material	Finishing			Length	Material thickness	Packing unit Chain form
						blank	Sn	Ni			
				mm <sup>2</sup> AWG		un- plated	Sn	Ni	L 2 mm	mm	x 1000

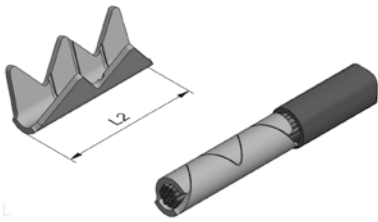

<b>RSB 7999 V-0,5</b>				0,13-0,5	CuZn	●	●		4,2	0,2	90
<b>RSB 7929 V-1</b>				0,5-1	CuZn	●	●		6,0	0,25	60

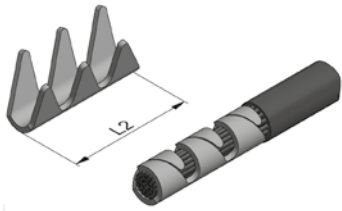

<b>RSB 7849 V-1</b>	46228 T3			0,5-1 20-18	CuZn Fe	●	●	●	6,1	0,25	60
<b>RSB 7908 V-1,5</b>				0,5-1,5	CuZn	●	●		6,0	0,3	40

● Standard-Artikel / Standard parts    ○ lieferbar auf Anfrage / available on request

# ADERENDHÜLSEN END SPLICES

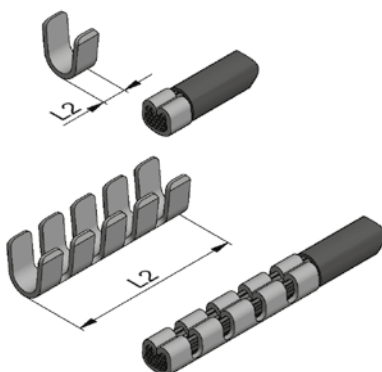
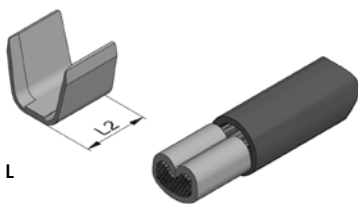
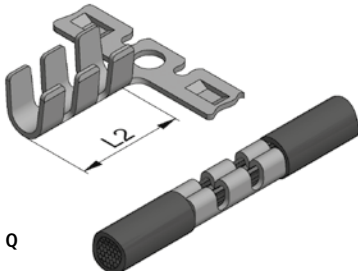
Bauform Q = Quertransport L = Längstransport  Supply condition Q = transverse transport / Side feed L = longitudinal transport / End feed	Artikel-Nummer	Freigaben s. Seite 7/8	Leiterquer- schnitt	Material	Veredlung			Länge	Material- stärke	Verp.-Einh. Bandform
	Part number	Approvals s. page 7/8	Wire size  mm <sup>2</sup> AWG	Material	blank	Sn	Ni	Length  L 2 mm	Material thickness  mm	Packing unit Chain form  x 1000
					un- plated	Finishing Sn Ni				
 <p>L</p>	<b>RSB 7735.001 V-1,5</b>		0,5-1,5 20-16	CuZn	●	●		(1x) 1,5 (2x) 3,8 (3x) 6,1 (4x) 8,4 (5x) 10,7	0,3	99
	<b>RSB 7837 V-2,5</b>		1,5-2,5 16-14	CuZn	●	●		(1x) 1,5 (2x) 3,8 (3x) 6,1 (4x) 8,4 (5x) 10,7	0,3	99
	<b>RSB 7894 V-4</b>	●	2,5-4 14-12	CuZn	●	●		(1x) 1,5 (2x) 4,0 (3x) 6,5	0,25	80
	<b>RSB 7912 V-10</b>		6-10 10-7	CuZn	●	●		(1x) 2,9 (2x) 6,65 (3x) 10,4 (4x) 14,15	0,5	30
	<b>RSB 8412 V-16</b>		10-16 6	CuZn	●	○		(1x) 2,8 (2x) 6,4 (3x) 10,0 (4x) 13,6 (5x) 17,2	0,5	20
 <p>L</p>	<b>RSB 7791 V-6</b>		2,5-6 12-10	CuZn CuSn	● ○	● ○		(1x) 5,0 (2x) 11,5	0,5	25
 <p>Q</p>	<b>RSB 8006 V-1,5</b>		0,5-1,5 20-16	CuZn	●	●		6,1	0,3	16

● Standard-Artikel / Standard parts ○ lieferbar auf Anfrage / available on request

Bauform Q = Quertransport L = Längstransport	Artikel-Nummer	DIN	UL	Leiterquer- schnitt	Material	Veredlung			Länge		Material- stärke	Verp.-Einh. Bandform
						blank	Sn	Ni	L 1 mm	L 2 mm		
						Finishing						
Supply condition Q = transverse transport / Side feed L = longitudinal transport / End feed	Part number	DIN	UL	Wire size	Material	un- plated	Sn	Ni	Length		Material thickness	Packing unit Chain form
				mm <sup>2</sup> AWG							mm	x 1000
	<b>RSB 7770 V-1</b>	46228 T2 B1-7		0,5-1 20-18	CuZn Fe	●	●	●	11,0	7,0	0,3	25
	<b>RSB 7771 V-1,5</b>	46228 T2 B1,5-7		0,75-1,5 18-16	CuZn Fe	●	●	●	11,0	7,0	0,3	20
	<b>RSB 7832 V-2,5</b>	46228 T2 B2,5-7		1,5-2,5 16-14	CuZn Fe	●	●	○	11,0	7,0	0,3	15
	<b>RSB 7806 V-1</b>			0,5-1 20-18	CuZn	○	○		13,0	9,0	0,25	22
	<b>RSB 8061 V-1,5</b>	46228 T2 B 1,5-7		0,75-1,5 18-16	CuZn Fe	○	○	●	7,4	4,6	0,3	4

● Standard-Artikel / Standard parts   ○ lieferbar auf Anfrage / available on request

# SONDERADERENDHÜLSEN SPECIAL END SPLICES

Bauform Q = Quertransport L = Längstransport  Supply condition Q = transverse transport / Side feed L = longitudinal transport / End feed	Artikel-Nummer	DIN UL	Leiterquer- schnitt	Material	Veredlung			Länge		Material- stärke	Verp.-Einh. Bandform			
	Part number		Wire size		Material	Finishing			Length			Material thickness	Packing unit Chain form	
						blank	Sn	Ni	L 1 mm					L 2 mm
						un- plated	Sn	Ni						
mm <sup>2</sup> AWG														
 Q	<b>RVB 8131 V-0,6</b> Für Lackdraht For magnet wire		0,22-0,75 24-20	CuZn	○	○		3,2	0,45	30				
	 Q	<b>RVB 8131.001 V-06</b> für Lackdraht For magnet wire	0,22-0,75 24-20	CuZn	○	●		6,7	3,2	0,45	30			
 Q		<b>RSB 7884.001 V 0-10</b>	6-10 8-8	CuZn	●	○		10,0	0,3	4				
	<b>RSB 7884.003 V 0-10</b>	4-10 10-8	CuZn		○		10,0	0,5	4					
 Q	<b>RSB 7884.004 V 0-16</b>		10-16 10-6	CuZn	○	○		10,0	0,5	2,5				

● Standard-Artikel / Standard parts    ○ lieferbar auf Anfrage / available on request



Bauforn Q = Quertransport L = Längstransport  Supply condition Q = transverse transport / Side feed L = longitudinal transport / End feed	Artikel-Nummer	Freigabe s. Seiten 7/8	Leiterquer- schnitt	Material	Veredlung			Innen Ø	Länge		Material- stärke	Verp.-Einh. Bandform
	Part number	Approvals s. page 7/8	Wire size  mm <sup>2</sup> AWG	Material	blank	Sn	Ni		Length			
					un- plated	Sn	Ni	Inside Ø	L 1 mm	L 2 mm	mm	x 1000

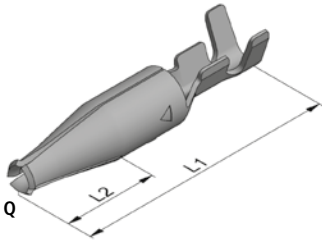

<b>RBB 7994.002 F 2,3-0,75</b>			0,22-0,5 24-22	CuSn		●		2,36	21,0	7,6	0,4	4,5
--------------------------------	--	--	-------------------	------	--	---	--	------	------	-----	-----	-----

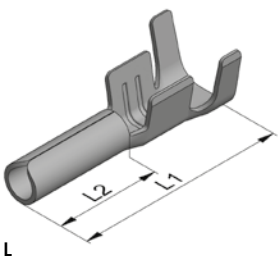

<b>RBB 8110 R 1,85-1,5</b>			1-1,5 18-16	CuZn Fe	○	○		1,83	14,3	7,2	0,3	10
<b>RBB 8110.001 R 1,93-1,5</b>			0,5-1,5 20-16	CuZn Fe	○	○		1,92	14,3	7,2	0,3	10

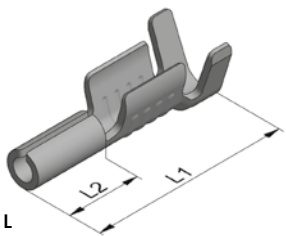

<b>RBB 7995.003 R 1,2-1</b>		●	0,5-1 20-18	X5CrNi	●			1,29	12,0	4,5	0,4	20
<b>RBB 7995.005 R 1,4-1</b>			0,5-1 20-18	X5CrNi	●			1,49	12,0	4,5	0,4	20
<b>RSB 7836 R 3,8-1</b>			0,5-1 20-18	CuZn	○	○		3,85	20,7	10,0	0,4	8

● Standard-Artikel / Standard parts    ○ lieferbar auf Anfrage / available on request

# RUNDSTECKHÜLSEN SOCKETS

Bauform Q = Quertransport L = Längstransport  Supply condition Q = transverse transport / Side feed L = longitudinal transport / End feed	Artikel-Nummer	Freigabe s. Seiten 7/8	Leiterquer- schnitt	Material	Veredlung			Innen Ø	Länge		Material- stärke	Verp.-Einh. Bandform
	Part number	Approvals s. page 7/8	Wire size  mm <sup>2</sup> AWG	Material	Finishing			Inside Ø	Length		Material thickness	Packing unit Chain form
					blank	Sn	Ni		L 1 mm	L 2 mm		
					un- plated			mm			mm	mm

Leicht aufsteckbar  
Low insertion force

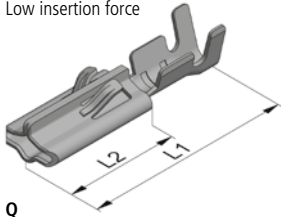

Q

<b>RFB 8185 R 1,3-0,75</b> Für Gehäusemontage For housings		0,35-0,75 22-18	CuSn	●	●		1,22	14,2	7,85	0,25	5,5
--	--	--------------------	------	---	---	--	------	------	------	------	-----

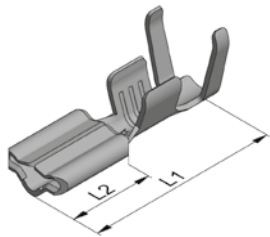

L

<b>RFB 8121.115 R 1,5-1,5</b> Leicht aufsteckbar Low insertion force		0,5-1,5 20-16	Fe			●	1,38	14,3	6,3	0,35	7
<b>RFB 8121.020 R 2-1,5</b>	●	0,5-1,5 20-16	Fe			○	1,87	14,3	6,3	0,35	7
<b>RFB 8121.022 R 2,25-1,5</b>		0,5-1,5 20-16	Fe			○	2,08	14,3	6,3	0,35	7
<b>RFB 8121.025 R 2,5-1,5</b>	●	0,5-1,5 20-16	Fe			○	2,36	14,3	6,3	0,35	7

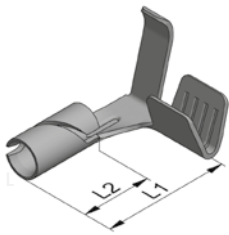

L

<b>RBB 8069 R 1,9-1,5</b>		0,75-1,5 18-16	Fe			●	1,9	9,0	5,0	0,32	5
<b>RBB 8069.002 R 1,95-0,34</b>		0,13-0,35 26-22	CuZn	○			1,95	9,0	5,0	0,30	5

● Standard-Artikel / Standard parts    ○ lieferbar auf Anfrage / available on request

Bauform Q = Quertransport L = Längstransport  Supply condition Q = transverse transport / Side feed L = longitudinal transport / End feed	Artikel-Nummer	Leiterquer- schnitt	Material	Veredlung			Außen Ø	Länge		Material- stärke	Verp.-Einh. Bandform
	Part number	Wire size	Material	Finishing			Outside Ø	Length		Material thickness	Packing unit Chain form
				blank	Sn	Ni		L 1 mm	L 2 mm		
		mm <sup>2</sup> AWG		un- plated	Sn	Ni	mm			mm	x 1000

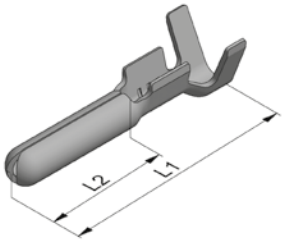

Q

<b>RTB 7861.003 P 2,4-0,75</b>	0,5-0,75 20	CuZn	●				2,36	16,8	9,2	0,35	4
--------------------------------	----------------	------	---	--	--	--	------	------	-----	------	---

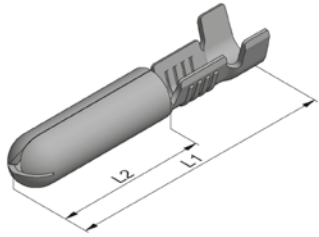

L

<b>RSB 7835 P 4-1</b>	0,5-1 20-18	CuZn	○	○			4,0	23,0	13,4	0,45	9
-----------------------	----------------	------	---	---	--	--	-----	------	------	------	---

● Standard-Artikel / Standard parts    ○ lieferbar auf Anfrage / available on request

# SONDERANSCHLUSSTEILE SPECIAL CONNECTORS

Bauform Q = Quertransport L = Längstransport  Supply condition Q = transverse transport / Side feed L = longitudinal transport / End feed	Artikel-Nummer	Leiter- quer- schnitt	Material	Veredlung			Abmessungen			Material- stärke	Verp.-Einh. Bandform
	Part number	Wire size	Material	Finishing			Dimensions			Material thickness	Packing unit Chain form
				blank	Sn	Ni	B 1 mm	L 1 mm	L 2 mm		
		mm <sup>2</sup> AWG		un- plated	Sn	Ni				mm	x 1000

Board-in Crimpkontakte für Leiterplatten  
Crimp contacts for printed boards

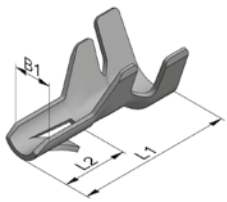

Q

RSB 7918.001  $\phi$ 1.3  
RSB 7918.002  $\phi$ 1.85

<b>RSB 7918.001 V 1,2-0,35</b>	0,13-0,35 26-22	CuZn		●		1,22	6,6	2,75	0,2	12
<b>RSB 7918.002 V 1,6-0,8</b>	0,35-1 22-18	CuZn		●		1,63	6,6	2,75	0,2	8

● Standard-Artikel / Standard parts    ○ lieferbar auf Anfrage / available on request

- Isolierkörper 2,8 - 4,8 - 6,3 mm
- Gehäuse für Standard- und leicht aufsteckbare Flachsteckhülsen, gerade Ausführung
- Insulation housings 2,8 - 4,8 - 6,3 mm
- Housings for standard and low insertion force receptacles, straight version

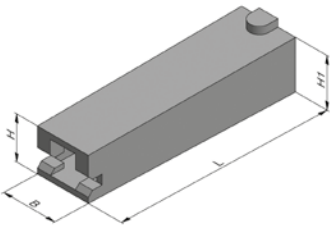
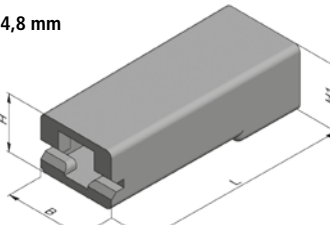
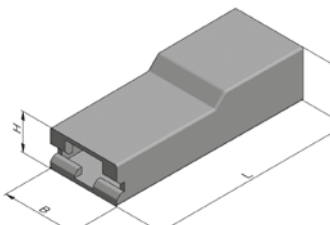
Bauform Supply condition	Artikel-Nummer Part number	Material	Brennbarkeitsklasse Flammability class			Farbe Colour	Polzahl Positions	Abmessungen mm Dimensions mm				Verp.- Einh. Packing unit	Zugehörige Artikel Fitting parts unit
			V 0	V 2	GWT 750 °C *			L	B	H	H 1		
<b>2,8 mm</b> 	EH 657.100	PA 66 PA 6/66	●	●		natur natural	1	19,8	5,2	4,0	4,6	50	RSB 7785 RSB 7990 RSB 8100
	EH 657.100-G	PA 6		●	●								
	EH 657.100	PA 66 PA 46 PA 6/66	●	●		schwarz black							
	EH 657.100-G	PA 6	●	●	●								
<b>4,8 mm</b> 	EH 650.100	PA 66 PA 6/66	●	●		natur natural	1	20,0	8,0	5,4	6,0	25	RSB 7603 RSB 7604 RSB 8270
	EH 650.100-G	PA 6		●	●								
	EH 650.100	PA 46	●			schwarz black							
<b>6,3 mm</b> 	EH 649	PA 66 PA 6/66	●	●		natur natural	1	25,0	9,5	4,8	6,2	15	RSB 8115 RSB 7900 RSB 7901 RSB 8152 RSB 8260
	EH 649-G	PA 6 PA 66	●	●	●								
	EH 649	PA 66 PA 6/66	●	●		schwarz black							
	EH 649-G	PA 6 PA 66	●	●	●								
	EH 681	PA 66 PA 6/66	●	●		natur natural	1	25,0	9,15	5,2	6,1	15	RSB 8137 RSB 8238.158 RSB 8238.258 RSB 8136 (3 mm² max.)
	EH 681-G	PA 66		●	●								
	EH 681	PA 66 PA 6/66	●	●		schwarz black							
	EH 681-G	PA 6		●	●								

\* glühdrahtbeständig, GWT 750 °C nach IEC 60335-1 – glow wire resistant, GWT 750 °C. acc. to IEC 60335-1

Andere Materialien und Farben auf Anfrage – Other materials / colors on request  
Freigaben: siehe Seite 9 – Approvals: see page 9

# ISOLIERKÖRPER INSULATION HOUSINGS

- Isolierkörper 4,8 - 6,3 mm
- Gehäuse für Standard- und leicht aufsteckbare Flachsteckhülsen, Winkelausführung

- Insulation housings 4,8 - 6,3 mm
- Housings for standard and low insertion force receptacles, flag type version

Bauform	Artikel-Nummer	Material	Brennbarkeitsklasse			Farbe	Polzahl	Abmessungen mm				Verp.-Einh.	Zugehörige Artikel
Supply condition	Part number	Material	Flammability class			Colour	Positions	Dimensions mm				Packing unit	Fitting parts
			V 0	V 2	GWT 750 °C *			L	B	H	H 1	x 1000	

4,8 mm

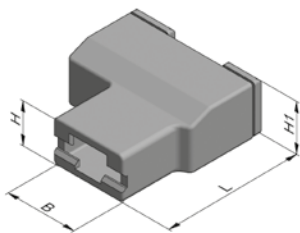

<b>EH 683.002</b>	PA 66	●			natur	1	14,2	7,5	4,4	5,2	20	RSB 7936.002 RSB 7936.003 RSB 8186.155 RSB 8186.158
	PA 6/66	●			natur							
<b>EH 683.002-G</b>	PA 6		●	●								
<b>EH 683.002</b>	PA 66		●		schwarz black	1	14,2	7,5	4,4	5,2	20	
	PA 46		●									
	PA 6/66	●										
<b>EH 683.002-G</b>	PA 6		●	●								

6,3 mm

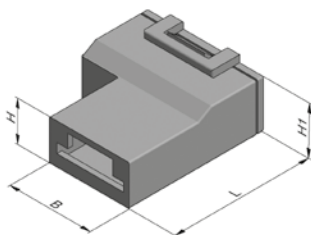

<b>EH 678.100-B</b>	PA 66	●		●	natur	1	16,2	9,6	4,8	5,7	15	RSB 7944 RSB 8240.158
<b>EH 678.100</b>	PA 66		●		schwarz black							
<b>EH 679.200</b>	PA 66		●		natur	1	18,8	9,6	4,8	6,2	15	RSB 8138 RSB 8198.1208
	PA 6/66	●										
<b>EH 679.200-G</b>	PA 6		●	●								
<b>EH 679.200</b>	PA 66		●		schwarz black	1	18,8	9,6	4,8	6,2	15	
	PA 6/66	●										

6,3 mm

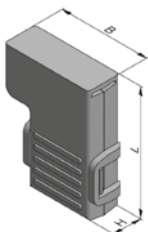

<b>EH 658.100</b>	PA 66		●		natur	1	18,0	13,4	5,2		12,5	RSB 8138
<b>EH 658.100-G</b>	PA 6		●	●	natur							
<b>EH 658.100</b>	PA 66		●		schwarz black	1	18,0	13,4	5,2		12,5	
<b>EH 658.100-G</b>	PA 6		●	●								

\* glühdrahtbeständig, GWT 750 °C nach IEC 60335-1 – glow wire resistant, GWT 750 °C. acc. to IEC 60335-1

Andere Materialien und Farben auf Anfrage – Other materials / colors on request  
Freigaben: siehe Seite 9 – Approvals: see page 9

- Isolierkörper 2,8 - 4,8 mm
- Gehäuse für verriegelbare Flachsteckhülsen
- Insulation housings 2,8 - 4,8 mm
- Housings for self locking receptacles

Bauform	Artikel-Nummer	Material	Brennbarkeitsklasse			Farbe	Polzahl	Abmessungen mm				Verp.-Einh.	Zugehörige Artikel
Supply condition	Part number	Material	Flammability class			Colour	Positions	Dimensions mm				Packing unit	Fitting parts
			V 0	V 2	GWT 750 °C *			L	B	H	H 1	x 1000	

**2,8 mm**  
Gerade Ausführung  
Straight version

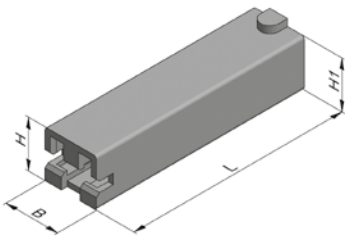

<b>EH 761</b>	PA 66		○		natur natural	1	21,0	5,2	4,7	4,7	50	RSB 8261.055 RSB 8261.058 RSB 8261.105 RSB 8261.108 RSB 8261.2055 RSB 8261.2058 RSB 8261.2105 RSB 8261.2108
<b>EH 761-G</b>	PA 66	●		●								

**4,8 mm**  
Gerade Ausführung  
Straight version

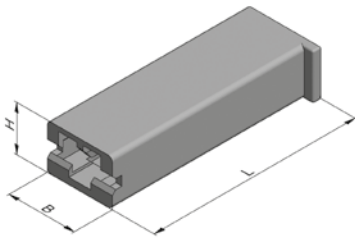

<b>EH 694.001</b>	PA 6	●		●	natur natural	1	23,0	7,1	5		15	RSB 8168.055 RSB 8168.058 RSB 8168.155 RSB 8168.158
<b>EH 694.001</b>	PA 6	●		●	schwarz black							
<b>EH 694.001</b>	PA 6	●		●	rot red							

**4,8 mm**  
Gerade Ausführung  
Straight version

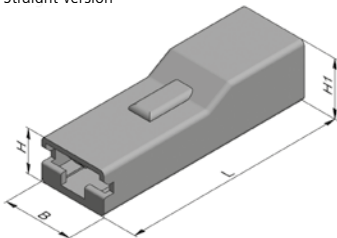

<b>EH 680</b>	PA 66 PA 6/66	●		●	natur natural	1	23,0	7,1	4,5	6,0	25	RSB 8028 RSB 8029
<b>EH 680-G</b>	PA 6			●								
<b>EH 680</b>	PA 66 PA 6/66	●		●	schwarz black							

\* glühdrahtbeständig, GWT 750 °C nach IEC 60335-1 – glow wire resistant, GWT 750 °C. acc. to IEC 60335-1

Andere Materialien und Farben auf Anfrage – Other materials / colors on request  
Freigaben: siehe Seite 9 – Approvals: see page 9

# ISOLIERKÖRPER INSULATION HOUSINGS

- Isolierkörper 6,3 mm
- Gehäuse für Flachsteckhülsen und Flachstecker
- Insulation housings 6,3 mm
- Housings for receptacles and tabs

Bauform	Artikel-Nummer	Material	Brennbarkeitsklasse			Farbe	Polzahl	Abmessungen mm				Verp.-Einh.	Zugehörige Artikel
Supply condition	Part number	Material	Flammability class			Colour	Positions	Dimensions mm				Packing unit	Fitting parts
			V 0	V 2	GWT 750 °C *			L	B	H	H 1	x 1000	

Gerade Ausführung  
Straight version

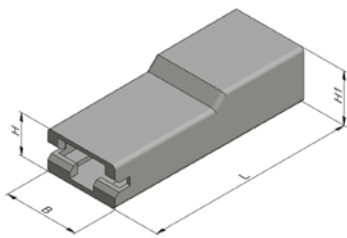

<b>EH 677</b>	PA 66		●			natur natural	1	25,0	9,3	5,0	6,3	10	RSB 7960 RSB 7960.020 RSB 7961 RSB 7961.020
<b>EH 677-G</b>	PA 66	●		●									
<b>EH 677</b>	PA 66		●			schwarz black							
<b>EH 677-G</b>	PA 66	●		●									
<b>EH 777</b>	PA 66		●			natur natural	1	25,0	9,3	5,0	6,3	15	RSB 8178.108 RSB 8178.258 RSB 8178.308
<b>EH 777-G</b>	PA 66	●		●									
<b>EH 777</b>	PA 66		●			schwarz black							
<b>EH 777-G</b>	PA 66	●		●									

Gerade Ausführung, für Flachstecker  
Straight version, for tabs

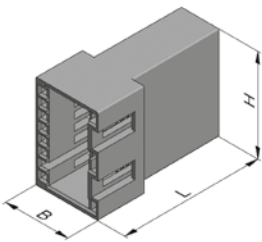

Codierung nach RAST 5  
Codification according to  
connector system RAST 5

<b>EH 788-002-**</b>	PA 6		●	●		natur natural	2	31,8	14,9	12,3	4	RMB 7831.010 RMB 7833.010 ***
	PA 66	●										
<b>EH 788-003-**</b>	PA 6		●	●		natur natural	3	31,8	14,9	17,3	3	RMB 7831.010 RMB 7833.010 ***
	PA 66	●										
<b>EH 788-004-**</b>	PA 6		●	●		natur natural	4	31,8	14,9	22,3	2,5	RMB 7831.010 RMB 7833.010 ***
	PA 66	●										
<b>EH 788-005-**</b>	PA 6		●	●		natur natural	5	31,8	14,9	27,3	2	RMB 7831.010 RMB 7833.010 ***
	PA 66	●										
<b>EH 788-006-**</b>	PA 6		●	●		natur natural	6	31,8	14,9	32,3	2	RMB 7831.010 RMB 7833.010 ***
	PA 66	●										

\* glühdrahtbeständig, GWT 750 °C nach IEC 60335-1 – glow wire resistant, GWT 750 °C. acc. to IEC 60335-1

\*\* Abartennummer gemäß RAST 5 Codiertabelle – Version number as per the RAST 5 polarizing chart

\*\*\* Ø max Isolierung / insulation = 3,1mm

Andere Materialien und Farben auf Anfrage – Other materials / colors on request

Freigaben: siehe Seite 9 – Approvals: see page 9



- Isolierkörper 6,3 mm
- Mehrfachgehäuse für Flachsteckhülsen
- Insulation housings 6,3 mm
- Multi-way housings for receptacles

Bauform	Artikel-Nummer	Material	Brennbarkeitsklasse			Farbe	Polzahl	Abmessungen mm			Verp.-Einh.	Zugehörige Artikel
Supply condition	Part number	Material	Flammability class			Colour	Positions	Dimensions mm			Packing unit	Fitting parts
			V 0	V 2	GWT 750 °C *			L	B	H	x 1000	

Gerade Ausführung  
Straight version

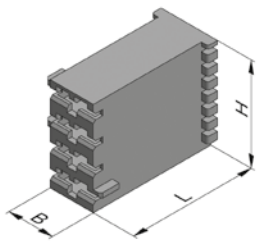

Codierung nach RAST 5  
Codification according to  
connector system RAST 5

<b>EH 688-002-**</b>	PA 6	●		●	natur natural	2	25,0	9,2	10	5	RSB 8178.108 RSB 8178.258 ***
<b>EH 688-003-**</b>	PA 6	●		●	natur natural	3	25,0	9,2	15	3,5	RSB 8178.108 RSB 8178.258 ***
<b>EH 688-004-**</b>	PA 6	●		●	natur natural	4	25,0	9,2	20	2,5	RSB 8178.108 RSB 8178.258 ***
<b>EH 688-005-**</b>	PA 6	●		●	natur natural	5	25,0	9,2	25	1,5	RSB 8178.108 RSB 8178.258 ***
<b>EH 688-006-**</b>	PA 6	●		●	natur natural	6	25,0	9,2	30	1	RSB 8178.108 RSB 8178.258 ***
<b>EH 688-007-**</b>	PA 6	●		●	natur natural	7	25,0	9,2	35	0,5	RSB 8178.108 RSB 8178.258 ***
<b>EH 688-008-**</b>	PA 6	●		●	natur natural	8	25,0	9,2	40	0,5	RSB 8178.108 RSB 8178.258 ***

Gerade Ausführung  
Straight version

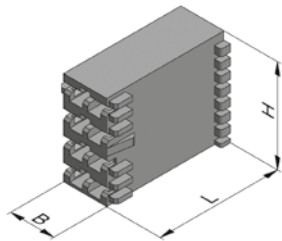

Codierung nach RAST 5  
Codification according to  
connector system RAST 5

<b>EH 688.400-002-**</b>	PA 6	●		●	natur natural	2	25,0	9,2	10	5	RSB 8178.1108 RSB 8178.1258 ***
<b>EH 688.400-003-**</b>	PA 6	●		●	natur natural	3	25,0	9,2	15	3,5	RSB 8178.1108 RSB 8178.1258 ***
<b>EH 688.400-004-**</b>	PA 6	●		●	natur natural	4	25,0	9,2	20	2,5	RSB 8178.1108 RSB 8178.1258 ***
<b>EH 688.400-005-**</b>	PA 6	●		●	natur natural	5	25,0	9,2	25	1,5	RSB 8178.1108 RSB 8178.1258 ***
<b>EH 688.400-006-**</b>	PA 6	●		●	natur natural	6	25,0	9,2	30	1	RSB 8178.1108 RSB 8178.1258 ***
<b>EH 688.400-007-**</b>	PA 6	●		●	natur natural	7	25,0	9,2	35	0,5	RSB 8178.1108 RSB 8178.1258 ***
<b>EH 688.400-008-**</b>	PA 6	●		●	natur natural	8	25,0	9,2	40	0,5	RSB 8178.1108 RSB 8178.1258 ***

\* glühdrahtbeständig, GWT 750 °C nach IEC 60335-1 – glow wire resistant, GWT 750 °C. acc. to IEC 60335-1

\*\* Abartennummer gemäß RAST 5 Codiertabelle – Version number as per the RAST 5 polarizing chart

\*\*\* Ø max Isolierung / insulation = 3,1mm

Andere Materialien und Farben auf Anfrage – Other materials / colors on request

Freigaben: siehe Seite 9 – Approvals: see page 9

# ISOLIERKÖRPER INSULATION HOUSINGS

- Isolierkörper 6,3 mm
- Mehrfachgehäuse für Flachsteckhülsen

- Insulation housings 6,3 mm
- Multi-way housings for receptacles

Bauform	Artikel-Nummer	Material	Brennbarkeitsklasse			Farbe	Polzahl	Abmessungen mm			Verp.-Einh.	Zugehörige Artikel
Supply condition	Part number	Material	Flammability class			Colour	Positions	Dimensions mm			Packing unit	Fitting parts
			V 0	V 2	GWT 750 °C *			L	B	H	x 1000	

Raster 5 mm  
Pitch 5 mm

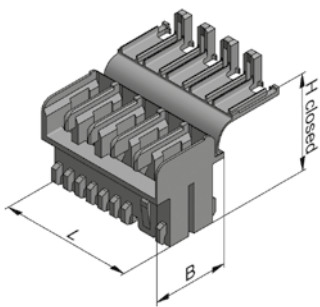

Codierung nach RAST 5  
Codification according to  
connector system RAST 5

<b>EH 699-002-**</b>	PA 6	●		●	natur natural	2	10	14,5	18	2	RSB 8240.1158 RSB 8240.1258
<b>EH 699-003-**</b>	PA 6	●		●	natur natural	3	15	14,5	18	2	RSB 8240.1158 RSB 8240.1258
<b>EH 699-004-**</b>	PA 6	●		●	natur natural	4	20	14,5	18	1	RSB 8240.1158 RSB 8240.1258
<b>EH 699-005-**</b>	PA 6	●		●	natur natural	5	25	14,5	18	1	RSB 8240.1158 RSB 8240.1258
<b>EH 699-006-**</b>	PA 6	●		●	natur natural	6	30	14,5	18	0,5	RSB 8240.1158 RSB 8240.1258
<b>EH 699-007-**</b>	PA 6	●		●	natur natural	7	35	14,5	18	0,5	RSB 8240.1158 RSB 8240.1258
<b>EH 699-008-**</b>	PA 6	●		●	natur natural	8	40	14,5	18	0,5	RSB 8240.1158 RSB 8240.1258

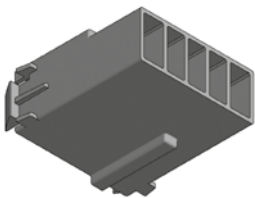
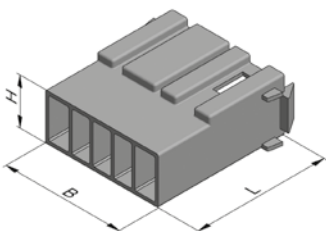

Codierung nach RAST 5  
Codification according to  
connector system RAST 5

<b>EH 798-003-025-960-G</b>	PA 6		●	●	natur natural	3	30	17	11	15	3 x RMB 7831.010
<b>EH 798-003-025-960</b>	PA 6/66	●									
<b>EH 798-005-020-960</b>	PA 6/66	●			natur natural	5	30	27	11	15	5 x RMB 7831.010

\* glühdrahtbeständig, GWT 750 °C nach IEC 60335-1 – glow wire resistant, GWT 750 °C. acc. to IEC 60335-1

\*\* Abartennummer gemäß RAST 5 Codetabelle – Version number as per the RAST 5 polarizing chart

Andere Materialien und Farben auf Anfrage – Other materials / colors on request  
Freigaben: siehe Seite 9 – Approvals: see page 9

- Isolierkörper 2,8 mm
- Gehäuse für Flachsteckhülsen und Flachstecker
- Insulation housings 2,8 mm
- Housings for receptacles and tabs

Bauform	Artikel-Nummer	Material	Brennbarkeitsklasse			Farbe	Polzahl	Abmessungen mm				Verp.-Einh.	Zugehörige Artikel
Supply condition	Part number	Material	Flammability class			Colour	Positions	Dimensions mm				Packing unit	Fitting parts
			V 0	V 2	GWT 750 °C *			L	B	H	H 1	x 1000	

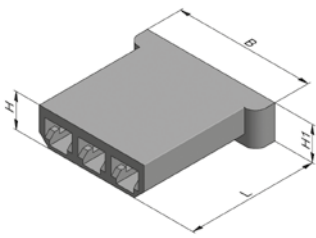

<b>EH 728</b>	PA 66		●			natur natural	3	18,0	19,2	5,0		15	3 x RSB 8280.1055 3 x RSB 8280.1058 3 x RSB 8280.1105 3 x RSB 8280.1108
---------------	-------	--	---	--	--	------------------	---	------	------	-----	--	----	--

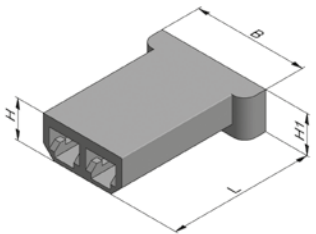

<b>EH 727.001</b>	PA 6		●	●		natur natural	2	18,0	14,2	5,0		15	2 x RSB 8280.1055 2 x RSB 8280.1058 2 x RSB 8280.1105 2 x RSB 8280.1108
<b>EH 727.002</b>	PA 6		●	●		schwarz black							

\* glühdrahtbeständig, GWT 750 °C nach IEC 60335-1 – glow wire resistant, GWT 750 °C. acc. to IEC 60335-1

Andere Materialien und Farben auf Anfrage – Other materials / colors on request  
Freigaben: siehe Seite 9 – Approvals: see page 9

# ISOLIERKÖRPER INSULATION HOUSINGS

- Isolierkörper 6,3 mm
- Gehäuse für Flachsteckhülsen und Flachstecker
- Insulation housings 6,3 mm
- Housings for receptacles and tabs

Bauform	Artikel-Nummer	Material	Brennbarkeitsklasse			Farbe	Polzahl	Abmessungen mm				Verp.-Einh.	Zugehörige Artikel
Supply condition	Part number	Material	Flammability class			Colour	Positions	Dimensions mm				Packing unit	Fitting parts
			V 0	V 2	GWT 750 °C *			L	B	H	H 1	x 1000	

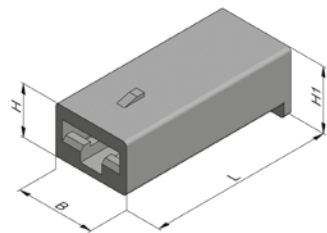
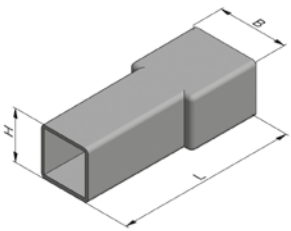

<b>VV 2023.100</b>	PA 66 PA 6/66	●	●		natur natural	1	31,6	12,5	9,3		6,5	1 x RMB 7831.010 1 x RMB 7833.010
<b>VV 2023.100-G</b>	PA 6		●	●								
<b>VV 2023.100</b>	PA 66		●		schwarz black							
<b>VV 2023.200</b>	PA 66		●	●	natur natural	1	23,0	9,9	6,5	8,1	13	1 x RSB 7858 1 x RSB 7916
<b>VV 2023.200-G</b>	PA 6		●	●								
<b>VV 2023.200</b>	PA 66		●	●	schwarz black							

Raster 8 mm  
Pitch 8 mm

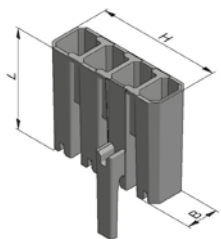

<b>EH 700/1</b>	PPS	●			schwarz black	1	25,2	10,2	7		2	RSB 8220.1158
<b>EH 700/2</b>	PPS	●			schwarz black	2	25,2	10,2	15		2	RSB 8220.1158
<b>EH 700/3</b>	PPS	●			schwarz black	3	25,2	10,2	23		2	RSB 8220.1158
<b>EH 700/4</b>	PPS	●			schwarz black	4	25,2	10,2	31		2	RSB 8220.1158

\* glühdrahtbeständig, GWT 750 °C nach IEC 60335-1 – glow wire resistant, GWT 750 °C. acc. to IEC 60335-1

Andere Materialien und Farben auf Anfrage – Other materials / colors on request  
Freigaben: siehe Seite 9 – Approvals: see page 9

- Isolierkörper 6,3 mm
  - Mehrfachgehäuse für Flachsteckhülsen und Flachstecker
- Insulation housings 6,3 mm
  - Multi-way housings for receptacles and tabs

Bauform	Artikel-Nummer	Material	Brennbarkeitsklasse			Farbe	Polzahl	Abmessungen mm				Verp.-Einh.	Zugehörige Artikel
Supply condition	Part number	Material	Flammability class			Colour	Positions	Dimensions mm				Packing unit	Fitting parts
			V 0	V 2	GWT 750 °C *			L	B	H	H 1	x 1000	

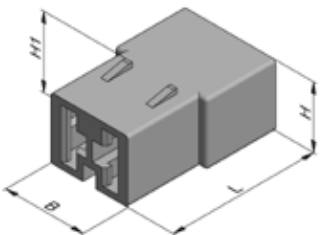
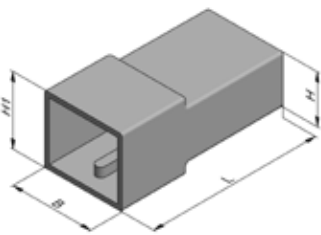

<b>VV 2025.100</b>	PA 66		●			natur natural	2	31,5	15,0	9,3	13,0	4	2 x RMB 7831.010 2 x RMB 7833.010
<b>VV 2025.100-G</b>	PA 6 PA 66			●	●								
<b>VV 2025.100</b>	PA 46		●										
<b>VV 2025.100</b>	PA 66		●			schwarz black							
<b>VV 2025.200</b>	PA 66 PA 46		●			natur natural	2	23,0	12,5	10,0	11,4	6,5	2 x RSB 7858 2 x RSB 7916
<b>VV 2025.200-G</b>	PA 6 PA 66			●	●								
<b>VV 2025.200</b>	PA 66		●			schwarz black							

\* glühdrahtbeständig, GWT 750 °C nach IEC 60335-1 – glow wire resistant, GWT 750 °C. acc. to IEC 60335-1

Andere Materialien und Farben auf Anfrage – Other materials / colors on request  
Freigaben: siehe Seite 9 – Approvals: see page 9

# ISOLIERKÖRPER INSULATION HOUSINGS

- Isolierkörper 6,3 mm
- Mehrfachgehäuse für Flachsteckhülsen und Flachstecker
- Insulation housings 6,3 mm
- Multi-way housings for receptacles and tabs

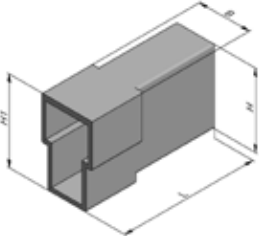
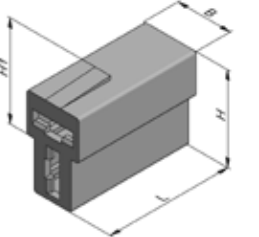
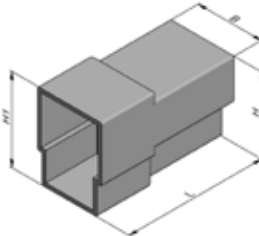
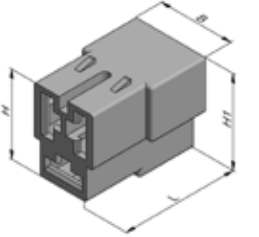
Bauform  Supply condition	Artikel-Nummer  Part number	Material	Brennbarkeitsklasse  Flammability class			Farbe  Colour	Polzahl  Positions	Abmessungen mm  Dimensions mm					Verp.- Einh.  Packing unit	Zugehörige Artikel  Fitting parts
			V 0	V 2	GWT 750 °C *			L	B	H	H 1			
												x 1000		
 	<b>VV 2041.100</b>	PA 66	●		natur natural	2	31,6	12,5	18,0	20,0	3,5	2 x RMB 7831.010 2 x RMB 7833.010		
	<b>VV 2041.100-G</b>	PA 6	●	●										
	<b>VV 2041.200</b>	PA 66	●		natur natural	2	23,0	10,0	16,6	18,0	7	2 x RSB 7858 2 x RSB 7916		
	<b>VV 2041.200-G</b>	PA 6	●	●										
 	<b>VV 2072.100</b>	PA 66	●		schwarz black	3	31,7	15,2	17,7	19,8	2,5	3 x RMB 7831.010 3 x RMB 7833.010		
	<b>VV 2072.100</b>	PA 66	●		natur natural									
	<b>VV 2072.100-G</b>	PA 6	●	●										
	<b>VV 2072.200</b>	PA 66	●		natur natural	3	23,0	15,2	16,6	17,8	4	3 x RSB 7858 3 x RSB 7916		
	<b>VV 2072.200-G</b>	PA 6	●	●										
	<b>VV 2072.200</b>	PA 66	●		schwarz black									

\* glühdrahtbeständig, GWT 750 °C nach IEC 60335-1 – glow wire resistant, GWT 750 °C. acc. to IEC 60335-1

Andere Materialien und Farben auf Anfrage – Other materials / colors on request  
Freigaben: siehe Seite 9 – Approvals: see page 9

- Isolierkörper 6,3 mm
- Mehrfachgehäuse für Flachsteckhülsen und Flachstecker
- Insulation housings 6,3 mm
- Multi-way housings for receptacles and tabs

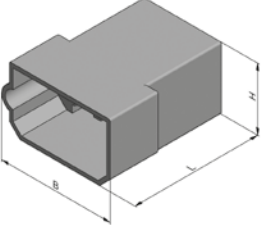
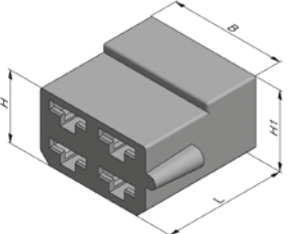
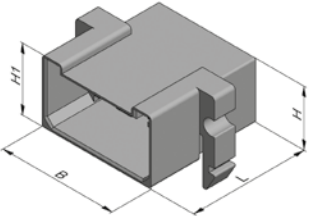
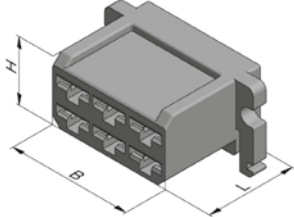
Bauform  Supply condition	Artikel-Nummer  Part number	Material	Brennbarkeitsklasse  Flammability class			Farbe  Colour	Polzahl  Positions	Abmessungen mm  Dimensions mm				Verp.- Einh.  Packing unit  x 1000	Zugehörige Artikel  Fitting parts
			V 0	V 2	GWT 750 °C *			L	B	H	H 1		
	<b>VV 2026.100</b>	PA 66	●		natur natural	4	32,3	28,5	16,4		1,75	4 x RMB 7831.010 4 x RMB 7833.010	
	<b>VV 2026.100-G</b>	PA 6	●	●									
	<b>VV 2026.100</b>	PA 66	●		schwarz black								
	<b>VV 2026.200</b>	PA 66	●		natur natural	4	24,0	23,0	13,8	15,5	2,5	4 x RSB 7858 4 x RSB 7916	
	<b>VV 2026.200-G</b>	PA 6	●	●									
	<b>VV 2026.200</b>	PA 66	●		schwarz black								
	<b>VV 2028.100</b>	PA 66	●		natur natural	6	32,0	31,4	16,1	18,0	1	6 x RMB 7831.010 6 x RMB 7833.010	
	<b>VV 2028.100-G</b>	PA 6	●	●									
	<b>VV 2028.100</b>	PA 66	●		schwarz black								
	<b>VV 2028.300</b>	PA 66	●		natur natural	6	24,0	28,3	15,2		2	6 x RSB 7858 6 x RSB 7916	

\* glühdrahtbeständig, GWT 750 °C nach IEC 60335-1 – glow wire resistant, GWT 750 °C. acc. to IEC 60335-1

Andere Materialien und Farben auf Anfrage – Other materials / colors on request  
Freigaben: siehe Seite 9 – Approvals: see page 9

# ISOLIERKÖRPER INSULATION HOUSINGS

- Isolierkörper 6,3 mm
- Mehrfachgehäuse für Flachsteckhülsen und Flachstecker
- Insulation housings 6,3 mm
- Multi-way housings for receptacles and tabs

Bauform	Artikel-Nummer	Material	Brennbarkeitsklasse			Farbe	Polzahl	Abmessungen mm				Verp.-Einh.	Zugehörige Artikel
Supply condition	Part number	Material	Flammability class			Colour	Positions	Dimensions mm				Packing unit	Fitting parts
			V 0	V 2	GWT 750 °C *			L	B	H	H 1	x 1000	

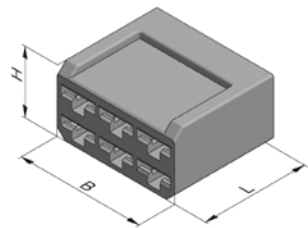
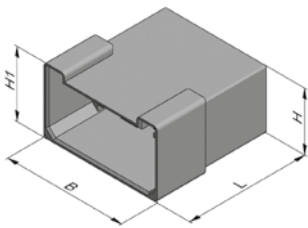

<b>VV 2028.110</b>	PA 66		●		natur natural	6	32,0	31,5	16,0	18,5	1,25	6 x RMB 7831.010 6 x RMB 7833.010
<b>VV 2028.110-G</b>	PA 6		●	●								
<b>VV 2028.110</b>	PA 66		●		schwarz black							
<b>VV 2028.200</b>	PA 66		●		natur natural	6	24,2	28,6	15,5		2,5	6 x RSB 7858 6 x RSB 7916
<b>VV 2028.200-G</b>	PA 6		●	●								
<b>VV 2028.200</b>	PA 66		●		schwarz black							

\* glühdrahtbeständig, GWT 750 °C nach IEC 60335-1 – glow wire resistant, GWT 750 °C, acc. to IEC 60335-1

Andere Materialien und Farben auf Anfrage – Other materials / colors on request  
Freigaben: siehe Seite 9 – Approvals: see page 9

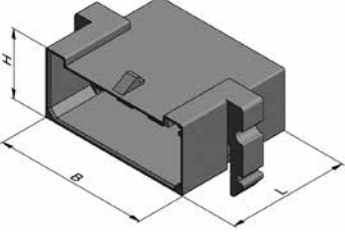
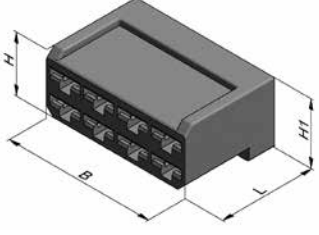
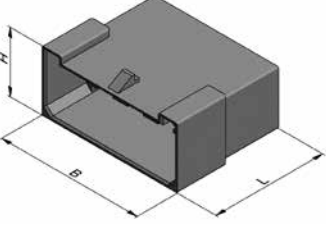

- Isolierkörper 6,3 mm
- Mehrfachgehäuse für Flachsteckhülsen und Flachstecker
- Insulation housings 6,3mm
- Multi-way housings for receptacles and tabs

Bauform  Supply condition	Artikel-Nummer  Part number	Material	Brennbarkeitsklasse  Flammability class			Farbe  Colour	Polzahl  Positions	Abmessungen mm  Dimensions mm				Verp.- Einh.  Packing unit	Zugehörige Artikel  Fitting parts
			V 0	V 2	GWT 750 °C *			L	B	H	H 1		
	<b>VV 2029.100</b>	PA 66		●		natur natural	8	32,0	40,7	18,1		0,75	8 x RMB 7831.010 8 x RMB 7833.010
	<b>VV 2029.100</b>	PA 66		●		schwarz black							
	<b>VV 2029.200</b>	PA 66		●		natur natural	8	24,2	37,6	13,7	16,5	1,5	8 x RSB 7858 8 x RSB 7916
	<b>VV 2029.200</b>	PA 66		●		schwarz black							
	<b>VV 2029</b>	PA 66		●		natur natural	8	32,0	40,5	18,1		1	8 x RMB 7831.010 8 x RMB 7833.010

\* glühdrahtbeständig, GWT 750 °C nach IEC 60335-1 – glow wire resistant, GWT 750 °C. acc. to IEC 60335-1

Andere Materialien und Farben auf Anfrage – Other materials / colors on request  
Freigaben: siehe Seite 9 – Approvals: see page 9

UL-Freigaben und eine einwandfreie Verdringung unserer Produkte sind nur dann gewährleistet, wenn die Verarbeitung auf STOCKO-Werkzeugen erfolgt.  
UL approvals and correct crimping only ensured on products crimped with STOCKO applicators.

**Drahtcrimp  
Conductor crimp**

**Isolationscrimp  
Insulation crimp**

**Längeneinstellung  
Length adjustment**

	Richtig Correct	Falsch Incorrect	Falsch Incorrect	Crimphöhen-Messung* Measuring the crimp height*
		 Crimphöhe zu hoch Volumen zu klein Crimp height too high Volume too small	 Überpressung! Volumen zu klein Stempelverschleiß Over-crimped! Volume too small Worn punch	
		 Volumen zu klein Volume too small	 Crimphöhe zu niedrig Volumen zu klein Crimp height too low Volume too small	
		 Volumen zu groß Volume too large	 Volumen zu klein Volume too small	
		 Volumen zu groß Volume too large	 Crimphöhe zu hoch Volumen zu klein Crimp height too high Volume too small	
		 Zu weit eingelegt Isolation im Drahtcrimp Cable inserted too deep Insulation in wire crimping bucket	 Nicht weit genug eingelegt Isolation nicht sichtbar Cable inserted not deep enough Insulation invisible	

**Leiterauszugskraft:**

Eine Kontrollmessung ohne Isolationskralle wird mit dem entsprechenden Gerät vorgenommen.  
Die Meßwerte sind mit den Angaben des Crimp-Datenblattes zu vergleichen.

**Tensile strength (crimped conductor)**

Tension of conductor crimp to be measured with a suitable instrument (without insulation crimp).  
The values obtained are to be compared with the specification of the data sheet.



**\*Crimphöhen-Messung**

**\*Measuring the crimp height**

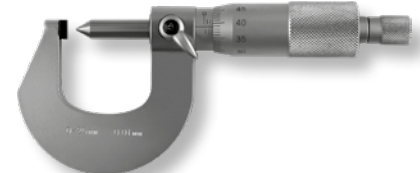

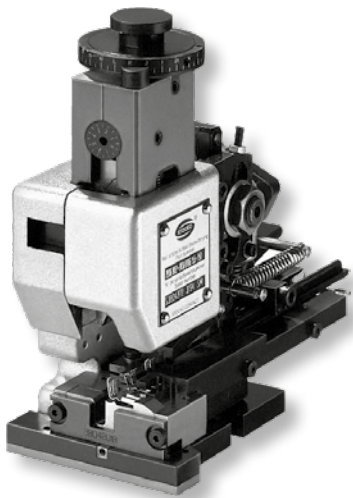

#### Schnellwechselwerkzeuge für Längstransport

Schnellwechselwerkzeug für Artikel, die hintereinander angebunden sind.  
Der Vorschub erfolgt mechanisch.  
Diese Variante ist geeignet für die Verarbeitung von Artikeln bis max. 31 mm Transportlänge.  
Option: Werkzeug mit pneumatischem Vorschub.

#### Quick-change tools for longitudinal transport

Quick-change tool for products which are mounted in line.  
Mechanical feed system.  
This version is suitable for terminating products with up to 31 mm feed length.  
On option, we can provide a pneumatic feed system.

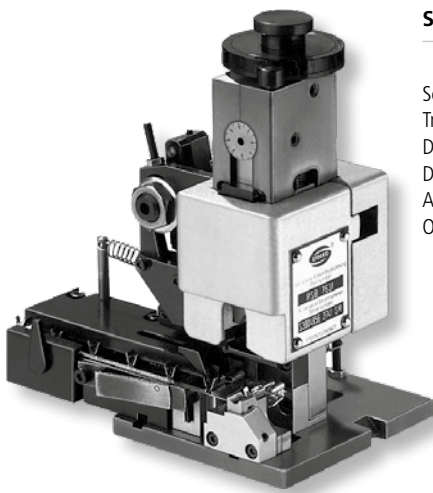

#### Schnellwechselwerkzeuge für Quertransport

Schnellwechselwerkzeug für Artikel, die quer an den Transportstreifen angebunden sind.  
Der Vorschub erfolgt mechanisch.  
Diese Variante ist geeignet für die Verarbeitung von Artikeln bis max. 25 mm Transportlänge.  
Option: Werkzeug mit pneumatischem Vorschub.

#### Quick-change tools for transverse transport

Quick-change tool for products which are mounted side by side on the carrier strip.  
Mechanical feed system.  
This version is suitable for terminating products with up to 25 mm feed length.  
On option, we can provide a pneumatic feed system.

Die Anwendungsparameter von Steckverbindern und Kontakten werden in Datenblättern und Katalogen definiert. STOCKO-Produkte sind darauf ausgelegt, innerhalb der vorgegebenen Spezifikationen betrieben zu werden. Jede Anwendung unserer Produkte außerhalb der in den Spezifikationen zugelassenen Grenzwerte kann gefährlich sein und die Nichtbeachtung der folgenden Hinweise kann deshalb schwerwiegende Folgen haben.

## Eigenschaften der eingesetzten Materialien

Verwendet werden flammgeschützte thermoplastische Isolationswerkstoffe, Kontaktmaterialien auf Kupfer- oder Stahlbasis und Oberflächenbeschichtungen aus Zinn, Nickel oder Gold. In Einzelfällen, z.B. bei kundenspezifischen Produkten, können auch andere hier nicht aufgeführte Materialien zum Einsatz kommen. Die für die jeweiligen Produkte eingesetzten Materialien können je nach Anwendung variieren und auf die spezifischen Anforderungen abgestimmt sein.

Wenn die Steckverbinder und Kontakte in den in Spezifikationen und Datenblättern angegebenen Grenzen betrieben werden, bleiben die technischen Eigenschaften langfristig stabil. Werden jedoch durch besondere Betriebsbedingungen oder im Störfall die Grenzwerte überschritten oder die Steckverbinder und Kontakte z.B. extremen Umweltbedingungen ausgesetzt, können sich die Eigenschaften der eingesetzten Materialien verändern.

Die fehlerhafte Kontaktierung eines Leiters mit ungeeigneten Werkzeugen, deformierte oder gebrochene Kontakte, Überschreitung der zulässigen Strombelastung, unvollständige Steckung der Stecker und Kontakte oder schlecht gelötete Kontakte können zu einer Überschreitung der zulässigen Grenztemperatur einer Steckverbindung oder eines Kontaktes führen. In diesen Fällen kann das Isolationsmaterial in seinen elektrischen Eigenschaften beeinträchtigt werden und bei Berührung die Gefahr eines elektrischen Schlags bestehen.

Hält eine Überhitzung über die spezifizizierte Grenztemperatur längere Zeit an, baut sich die Kontaktkraft der Federkontakte ab und Oxidschichten bilden sich auf Kontakten und Drähten. Der Kontaktwiderstand steigt dadurch an, weitere Temperaturerhöhungen sind die Folge und das Isolationsmaterial kann bis hin zur Verkohlung geschädigt werden. Auf Grund dieser thermischen Schädigung des Isolationsmaterials können sich Kriech- oder Leckströme bilden. Dabei können Flammen entstehen, die brennbares Material in der Umgebung entzünden und unter Umständen Brände auslösen.

Eine sorgfältige Behandlung von Steckverbindern und Kontakten auf dem Transport, in der Verarbeitung und in der Anwendung ist deshalb unbedingt notwendig. Beschädigungen können Gefährdungen nach sich ziehen. Vor dem Einbau sollten die Produkte deshalb geprüft und im Falle von fehlerhafter Verarbeitung oder vorhandener Beschädigung nicht weiterverwandt werden.

The suitability parameters for connectors and contacts are defined in the data sheets and catalogues. STOCKO products are designed to meet these specifications. To employ our products outside the specified parameters can be dangerous and neglecting the following information can have serious consequences.

## Properties of the materials employed

Materials used are thermoplastic insulation materials, contact materials based on copper or steel, and tin, nickel or gold surface finishes. Under special circumstances, like products to customers' specification, also other materials than those mentioned may be used. The selected materials for individual products can vary, being tuned according to application.

Provided connectors and contacts are used within the specified limits of the data sheets, the technical properties will remain stable over a long period of time. If, however, these limits are exceeded due to special circumstances or faulty production or due to exposure to extreme environmental conditions, the properties of the materials may change.

The faulty termination of contact and conductor with unsuitable tools, deformed or broken contacts, excessive current load, unfinished connections of connectors and contacts or badly soldered contacts can lead to exceeding the permissible temperature range of the connector or contact. In such event the insulating material may be impaired and, if touched, the danger of electric shock may exist.

Over-heating due to exceeding the specified temperature limits over a longer period will result in a reduction of the contact force of contacts and an oxide layer will build up on contacts and conductors. The contact resistance will increase and further temperature rises will result in damaging the insulating material with the danger of charring. Creeping or leakage currents can be formed owing to the thermal damaged insulation. This may cause combustion that ignites the surrounding inflammable material and may even start a fire.

A careful handling of connectors and contacts in all stages of transport, manufacture and application is absolutely important. Damaged components can create dangers. The products, therefore, should be examined before assembly and must not be further processed, if badly terminated or defective.



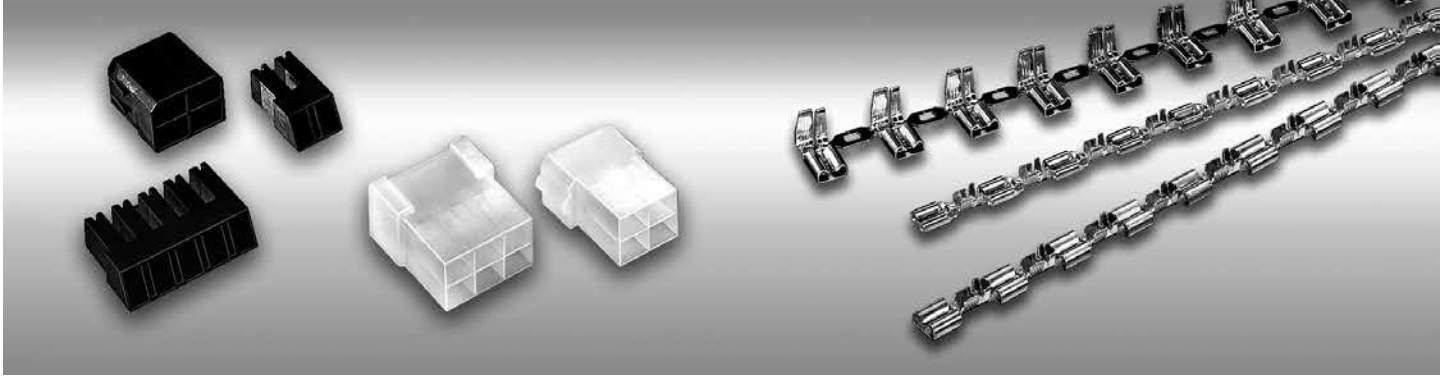

## Verarbeitung / Kabelbaumherstellung

Nur sorgfältig verarbeitete Steckverbinder und Kontakte erfüllen in der Anwendung die technischen Anforderungen. STOCKO-Ansatzwerkzeuge und -Maschinen sind auf die besonderen Produkteigenschaften abgestimmt. Prüfstationen überwachen die Qualitätsparameter, um eine hochwertige Verarbeitung der Steckverbinder und Kontakte sicherzustellen.

Für die Einhaltung der STOCKO-Qualitätskriterien auf Verarbeitungseinrichtungen anderer Hersteller trägt der Anwender die alleinige Verantwortung.

- Nur geschultes Personal sollte Steckverbinder und Kontakte verarbeiten.
- Bei der Verarbeitung von Steckverbindern und Kontakten müssen die STOCKO-Verarbeitungsspezifikationen berücksichtigt werden.
- Die Überwachung der produktspezifischen Qualitätsparameter muss nach STOCKO-Vorgaben erfolgen.
- Die eingesetzten Leitungen müssen von STOCKO für das jeweilige Steckverbindersystem oder den Kontakt freigegeben sein.
- Stellen Sie sicher, dass die Isolationsfähigkeit des Steckers nicht durch niederohmige Verbindungen wie Metallspäne, leitende Betriebsstoffe, lose Litzen oder leitende Verunreinigungen herabgesetzt ist, bevor die Stromkreise eingeschaltet werden.

## Steckverbinder und Kontakte in der Anwendung

In der Anwendung muss sichergestellt werden, dass die Steckverbinder und Kontakte spezifikationsgemäß eingesetzt werden.

- Die bestimmungsgemäße Funktion einer steckbaren Verbindung wird nur gewährleistet, wenn die Verbindung nach den Vorgaben montiert ist.
- Die zulässige Betriebsspannung hängt von der jeweiligen Anwendung, den gültigen nationalen Bestimmungen und anderen anwendbaren Sicherheitsbestimmungen ab. Die angegebene Betriebsspannung kann deshalb nur als Anhaltswert dienen und muss mit den nationalen Bestimmungen abgeglichen werden.
- Die in den Datenblättern und Spezifikationen angegebenen Temperaturwerte sind Grenztemperaturen und dürfen in der Anwendung nicht überschritten werden.
- Eine Verschmutzung der Steckverbinder und Kontakte darf den jeweils zulässigen Verschmutzungsgrad nicht überschreiten (siehe IEC 60 664). Leitende Verschmutzungen können Kriechströme verursachen. Dabei können Flammen entstehen, die brennbares Material in der Umgebung entzünden und Brände auslösen können.
- Eingeschaltete Stromkreise dürfen nicht durch Abziehen eines Steckers unterbrochen werden. Lichtbögen, Ionisation und ein Brand kann die Folge sein.
- Die Steckverbinderkomponenten mit berührbaren Kontakten sollten nicht auf der Stromversorgungsseite eingesetzt werden, da bei ungesteckten Verbindungen die Gefahr eines elektrischen Schlags besteht.

## Sonstige Hinweise

Durch den ständigen Verbesserungsprozess können sich die Produkte ändern. Abweichungen von Beschreibungen, technischen Daten und Darstellungen in den Katalogen sind deshalb möglich. Jede neue Ausgabe eines Kataloges macht vorausgehende Ausgaben ungültig.

## Harness processing assembly

Carefully processed connectors and contacts alone will meet the technical requirements in usage. STOCKO assembly tools and machines are adjusted to the specific product properties. Test stations control the quality parameters to safeguard the quality in processing the connectors and contacts.

To assure the STOCKO-quality requirements on processing devices of other manufacturers the user has to take sole responsibility.

- Only trained personnel should process connectors and contacts.
- Processing connectors and contacts the STOCKO manufacturing specifications must be observed.
- Product specific quality parameters must be controlled in accordance with STOCKO instructions.
- Conductors used with the respective connector system or contact must be approved by STOCKO.
- Before switching on the electric current, make sure that the insulating properties of the connector are not compromised by low ohmic connections like metal shavings, conductive materials, lose wires or conductive impurities.

## Application of connectors and contacts

When in use make sure that connectors and contacts are applied according to specification.

- The pre-determined function of a connector assembly can only be guaranteed if the connection is assembled according to instruction.
- The permissible operating voltage is subject to application, the legal national specifications and any other applicable safety requirements. The mentioned operating voltage can only serve as a guidance and must be adjusted to national requirements.
- The temperature values indicated in the data sheets are border-line temperatures and must not be surpassed under operating conditions.
- Contaminated connectors and contacts must not exceed the permissible degree of contamination (see IEC 60 664). Conductive contaminations can lead to creepage currents. They can create combustions that inflame surrounding inflammable materials and start fires.
- Switched-on circuitry must not be interrupted by pulling the plug. The result may be electric arcs, ionisation and fires.
- Connector components with touchable contacts must not be used as mains connections as unplugged connections can endanger electric shocks.

## Further Information

The products can be changed due to improvements. Changes and alterations from descriptions, technical data and illustrations in the catalogues are possible. Every new catalogue will make all earlier published versions invalid.



## Deutschland / Germany

Hauptsitz / Head quarter  
STOCKO Contact GmbH & Co. KG  
Simonshöfchen 31  
42327 Wuppertal  
Tel.: +49 202 9733 - 2 (Vertrieb)  
Tel.: +49 2482 84 - 0 (Verwaltung)  
Fax: +49 202 9733 - 411  
E-Mail: info@stocko-contact.com

**P** STOCKO Contact GmbH & Co. KG  
Olefallstr. 26  
53940 Hellenthal  
Tel.: +49 2482 - 0  
Fax: +49 2482 84 - 240  
E-Mail: hellenthal@stocko-contact.com  
Kundendienst Maschinenbau  
Schneidklemmtechnik (IDC):  
E-Mail: service-idc@stocko-contact.com

**D** HZ GmbH  
Technische Kunststoffe & Elektrische  
Verbindungstechnik  
Johannes-Giesser-Straße 11  
71364 Winnenden-Hertmannsweiler  
Tel.: +49 7195 59069 - 22  
Fax: +49 7195 59069 - 29  
E-Mail: mail@hz-gmbh.com

**D** Hoppe & Co. Electronic  
Inhaber Hans Zeltner e.K.  
Thomas-Mann-Straße 50  
90471 Nürnberg  
Tel.: +49 911 327175  
Fax: +49 911 327141  
E-Mail: info@hoppe-electronic.de

**D** zeb elektroTECHNIK GmbH  
Thomas-Mann-Straße 50  
90471 Nürnberg  
Tel.: +49 911 323957-0  
Fax: +49 911 327141  
E-Mail: info@zeb-gmbh.de

**D** LGV Electronic  
Distribution und Vertriebs GmbH  
Schieferstein 6  
65439 Flörsheim  
Tel.: +49 6145 9599-0  
Fax: +49 6145 9599-40  
E-Mail: info@lorenzgroup.com

**D** ETB Electronic Team  
Beratungs- und Vertriebs GmbH  
Wundramweg 1  
31303 Burgdorf  
Tel.: +49 5136 97229-0  
Fax: +49 5136 97229-39  
E-Mail: info@etb-electronic.de

## Australien / Australia

**D** Braemac Pty Ltd  
1/59-61 Burrows Road, Alexandria  
Sydney, NSW 2015 Australia  
Tel.: +61 2 95506600  
Fax: +61 2 95506377  
E-Mail: info@braemac.com.au

## Belgien, Luxemburg Belgium, Luxembourg

**D** ATEM N.V./S.A.  
Bedrijvenpark De Veert 4  
B-2830 Willebroek  
Tel.: +32 03 8661800  
Fax: +32 03 8661828  
E-Mail: info@atem.be

## Brasilien, Südamerika Brazil, South America

**SD** STOCKO CONTACT Brasil Ltda.  
Av. Paulista, 1439 – 1º andar CJ12  
01311-200 São Paulo / SP / Brasil  
Tel.: +55 11 4890 2223  
Mobil: +55 11 94251 2450  
E-Mail: brazil@stocko-contact.com

## China / China

**S** STOCKO CONTACT (Shanghai) Co. Ltd.  
Building D, No. 1388 SiCheng Road  
Malu Town, Jiading District  
Shanghai, P.R. China

STOCKO Contact GmbH & Co. KG  
Trading (Shanghai) Co. Ltd.  
7F, East Huaihai Int'l Mansion,  
No 49 Huaihai Road (E),  
Huang Pu District, Shanghai  
200010, PRC  
Tel.: +86 21 63555772-126 Vertrieb  
Tel.: +86 21 63555772-127  
Mobil: +86 136 36435222  
Fax: +86 21 6355 0090  
E-Mail: china@stocko-contact.com

**SD** STOCKO Contact GmbH & Co. KG  
#3-601, No.42 Dongshan 4th Road,  
Qingdao 266100, P.R.China  
Tel.: +86 139 69760609  
Fax: +86 532 66870622  
E-Mail: china@stocko-contact.com

**SD** STOCKO Contact GmbH & Co. KG  
No 147-149, Changping Avenue,  
Lian Guan Plaza, Room 1520,  
Guangdong Province, Dongguan City,  
Changping Town 523560,  
P.R.China  
Tel.: +86 137 1278 7427  
E-Mail: china@stocko-contact.com

**SD** STOCKO Contact GmbH & Co. KG  
Unit 08-1-302, No.184 Taishan Road  
New district Changzhou 213022,  
P.R.China  
Tel.: +86 136 85216240  
Fax: +86 519 88050927  
E-Mail: china@stocko-contact.com

**D** WG Industrial Control Equipment  
Suit. 22, No. 328, Hengyong RD  
Jiading District  
201806 Shanghai, P.R.China  
Tel.: +86 21 34533671  
Fax: +86 21 34311361  
E-Mail: sales@wg-ind.com

**D** Day-Suo Industrial (Shanghai) Co., Ltd  
3F, No. 54, Building 118, SuiDe Road  
Putuo Area, Shanghai City  
P.R. China  
Tel.: +86 21 52901576  
+86 134 82478060  
Fax: +86 21 62395570 ext. 608  
E-Mail: thomas@daysuo.com  
E-Mail: eason@daysuo.com

Qingdao Newlion Int'l Trading Co., Ltd.  
Unit 603 Baitong Building, No.26 Zaoyu-  
an Road,Licang District, Qingdao City  
P.R.China  
Telefon: +86 532 68078429  
Telefon: +86 134 82478060  
Telefax: +86 532 68078452  
E-Mail: new\_lion@163.com

## Dänemark / Denmark

**D** MATECH SYSTEMS A/S  
Ankelbovej 6  
7190 Billund  
Denmark  
Tel.: +45 75 338949  
Fax: +45 75 338946  
E-Mail: info@matechsystems.dk

## Estland, Lettland, Litauen Estonia, Latvia, Lithuania

**D** Adcontact/Gammeter  
Paldiski mnt 31  
EE - 76606 Keila, Harjumaa  
Tel.: +372 671 2251  
Fax: +372 671 2253  
E-Mail: info@gammeter.ee

## Finnland / Finland

**D** Adcontact AB Filial I Finland  
GAMMETER  
Vehnämlylynkatu 6  
FIN-33560 Tammerfors  
Finland  
Tel.: +358 3 3802211  
Fax: +358 3 3802244  
E-Mail: info@gammeter.fi

## Frankreich / France

**S** STOCKO CONTACT Eurl  
7, Route d'Eichhoffen  
CS 40017 Andlau  
67145 - BARR Cedex  
Tel.: +33 388 585858  
Fax: +33 388 585888  
E-Mail: andlau@stocko-contact.com

**D** CONNECT-SYSTEMES  
31, Impasse de la Balme  
69800 Saint-Priest  
Tel.: +33 4 78901315  
Fax: +33 4 78906332  
E-Mail: commercial@connect-systemes.fr  
(Rhône-Alpes, Centre, Sud, Est)

## Großbritannien, Irland, Republik Great Britain, Ireland, Republik of

**D** Cabletrix Ltd.  
9/10 James Watt Close  
Drayton Field Industrial Estate  
Daventry, Northants NN11 8QU, UK  
Tel.: +44 1327 876769  
Fax: +44 1327 300130  
E-Mail: sales@cabletrix.co.uk

**D** J-Tronics Ltd  
1 Granger Avenue  
Acomb  
York, YO26 5LF, UK  
Tel.: +44 1904 795690  
Fax: +44 1904 790887  
E-Mail: julie@j-tronics.co.uk

**D** New Force Ltd  
Fair Crest, Conghurst Lane  
Hawkhurst, Cranbrook  
Kent  
TN18 5DZ, UK  
Tel.: +44 1580 752014  
E-Mail: sales@new-force.co.uk

## Indien, Sri Lanka, VAE India, Sri Lanka, UAE

**D** AURO CONTROLS PRIVATE LIMITED  
Florina Apartment, 6th Floor,  
Survey No. 2/1/7, Erandwane,  
Pune 411004 INDIA  
Tel.: +912025465915  
E-Mail: sales@aurocontrols.com

## Indonesien / Indonesia

**D** PT. Esecodharma Permai  
Green Sedayu Biz Park Daan Mogot  
JL. Raya Daan Mogot KM.18  
Blok DM-2 No.18, Jakarta Barat, 11840  
Tel.: +62 21 5696 8822  
Fax: +62 21 5696 8811  
E-Mail: eseco-mkt@eseco.co.id

## Italien / Italy

**D** KLEMI Contact Srl  
Via Monferrato, 43  
I-20098 San Giuliano Milanese (MI)  
Tel.: +39 02 5560 6101  
Fax: +39 02 5560 7134  
E-Mail: klemi@klemi-contact.com

## Japan / Japan

**SD** STOCKO CONTACT Japan K.K.  
Across Cube Bldg. 2F 1-1-17 Shimoishii,  
Kita, Okayama 700-0907 Japan  
Tel: +81 86 2329825  
E-Mail: japan@stocko-contact.com

## Kanada / Canada

**D** WIELAND Electric Inc.  
3570 Platinum Drive,  
Units 6 & 7, Mississauga  
Ontario, L5M 2R7  
Canada  
Tel.: +1 905 8298414  
Toll Free: +1-800-Wieland  
Fax: +1 905 8298413  
E-Mail: technical.support@  
wieland.electric.com

**D** Sensible Micro Corporation  
13520 Prestige Place  
Tampa, FL 33635, USA  
Tel.: +1 877 9921930  
E-Mail: sales@sensiblemicro.com

## Korea / Korea

**SD** Stocko Contact GmbH & Co. KG  
Korea Office  
1611, 16F, Gangnam Bldg.  
396 Seocho-daero, Seocho-gu, Seoul  
06619, South Korea  
Tel.: +82 2-2190-3722  
Mobil: +82 10 5809 5970  
Fax: +82 2 2008 4555  
E-Mail: korea@stocko-contact.com

**D** ME Co. Ltd  
7, Jukjeon-ro, Uichang-gu, Changwon  
Gyeongnam, 51398  
Korea  
Tel.: +82 55 256-3910, -3970  
Fax: +82 55 256-3911  
E-Mail: prs7075@mecorp.co.kr

- P Zweigwerk / Plant  
S Tochtergesellschaft / Subsidiary  
SD Vertriebsbüro / Sales Office  
D Partner / Partners

#### Malaysia / Malaysia

D C.T.M. Industries Sdn. Bhd  
 (Penang Office)  
 14 & 16 Lorong Nagasari 4,  
 Kawasan Perusahaan Prai,  
 13600 Prai, Malaysia  
 Tel.: +60 4 397 9202  
 Fax: +60 4 397 9155  
 E-Mail: pg-ctm@ese-group.com

D C.T.M. Industries Sdn. Bhd  
 (Kuala Lumpur Office)  
 Suite 719, Blk B2,  
 Leisure Commerce Square,  
 No. 9, Jalan PJS 8/9,  
 46150 Petaling Jaya,  
 Selangor Darul Ehsan, Malaysia.  
 Tel.: +60 3 7875 3212  
 Fax: +60 3 7875 3302  
 Email: pg-ctm@ese-group.com

#### Mexiko / Mexico

SD STOCKO CONTACT GmbH & Co. KG  
 Sales Office Texas  
 El Paso  
 Tel.: +1 915 309 5363  
 E-Mail: mexico@stocko-contact.com

D Sensible Micro Corporation  
 13520 Prestige Place  
 Tampa, FL 33635, USA  
 Tel.: +1 877 9921930  
 E-Mail: sales@sensiblemicro.com

#### Niederlande / Netherlands

D AVT Industrial Components  
 Freddy van Riemsdijkweg 7  
 5657 EE Eindhoven  
 Tel.: +31 40 2088088  
 Fax: +31 40-2088099  
 E-Mail: sales@avtic.com

#### Norwegen / Norway

D Adcontact/Gammeter  
 P.O. Box 246 Skøyen  
 N-0213 Oslo  
 Tel.: +47 22417700  
 Fax: +47 22417701  
 E-Mail: info@adcontact.se

#### Österreich / Austria

D CODICO GmbH  
 Zwingenstraße 6-8  
 A-2380 Perchtoldsdorf  
 Tel.: +43 1 86305-0  
 Fax: +43 1 86305-5000  
 E-Mail: office@codico.com

#### Philippinen / Philippines

D C.T.P. Industries, Inc  
 Unit # 1001 Primeland Tower,  
 2218 Market Street,  
 Madrigal Business Park, Ayala Alabang,  
 Muntinlupa City, Philippines 1771  
 Tel.: +63 2 245 063-2 / -9  
 Fax: +63 2 836 7968  
 E-Mail: admin@ctp.com.ph

#### Polen / Poland

D EVOLTEC Tomasz Pawlowski  
 ul. Bekasów 63/65  
 02-803 Warszawa  
 Poland  
 Tel.: +48 22 55027-40 / - / -44  
 Fax: +48 22 550 27 45  
 E-Mail: info@evoltec.pl

#### Portugal / Portugal

SD STOCKO CONTACT GmbH & Co. KG  
 Vertriebsbüro Spanien / Portugal  
 F. Rius i Taullet, 19-3°  
 E-08850 Gavà (Barcelona)  
 Tel.: +34 936 627188  
 +34 676 490974  
 Fax: +34 936 627188  
 E-Mail: spain@stocko-contact.com

D TC Componentes, S.L.  
 Cami de Can Calders, 6 12-G  
 E-08173 Sant Cugat del Vallès  
 Barcelona  
 Tel.: +34 93 590 28 30  
 Fax: +34 93 590 02 67  
 E-Mail: info@tc-componentes.es

#### Schweden / Sweden

D Adcontact/Gammeter  
 Ursviksv. 127B  
 P.O. Box 7044  
 S-17407 Sundbyberg  
 Tel.: +46 8 4453600  
 Fax: +46 8 4453610  
 E-Mail: info@adcontact.se

#### Schweiz / Switzerland

D AWAG Elektrotechnik AG  
 Sandbühlstrasse 2  
 CH-8604 Volketswil  
 Tel.: +41 044 908 1919  
 Fax: +41 044 908 1999  
 E-Mail: info@awag.ch

#### Singapur / Singapore

SD STOCKO Contact GmbH & Co. KG  
 Liaison Office Singapur  
 Blk 5, Rivervale Crescent  
 # 08-05 Singapore 545084  
 Mobil: +65 91 832131  
 E-Mail: singapore@stocko-contact.com

D C.T.S. Industries Pte Ltd  
 53 Serangoon North Av. 4  
 #03-02/03  
 Singapore 555852  
 Tel.: +65 6276 3328  
 Fax: +65 6276 3336  
 E-Mail: sales\_cts@ese.com.sg

#### Slowakei, Slowenien Slovakia, Slovenia

D CODICO GmbH (via Partner)  
 Zwingenstraße 6-8  
 A-2380 Perchtoldsdorf  
 Tel.: +43 01 86305-0  
 Fax: +43 01 86305-5000  
 E-Mail: office@codico.com

#### Spanien / Spain

SD STOCKO CONTACT GmbH & Co. KG  
 Vertriebsbüro Spanien / Portugal  
 F. Rius i Taullet, 19-3°  
 E-08850 Gavà (Barcelona)  
 Tel.: +34 936 627188  
 +34 676 490974  
 Fax: +34 936 627188  
 E-Mail: spain@stocko-contact.com

D TC Componentes, S.L.  
 Cami de Can Calders, 6 12-G  
 E-08173 Sant Cugat del Vallès  
 Barcelona  
 Tel.: +34 93 590 28 30  
 Fax: +34 93 590 02 67  
 E-Mail: info@tc-componentes.es

#### Südafrika / South Africa

D APT Advanced Product Technology (PTY) LTD.  
 Corner Remblok and Langwa street  
 Strijdom Park  
 Randburg  
 Tel.: +27 11 7926010  
 Fax: +27 11 7929879  
 E-Mail: layla@apta.co.za

#### Taiwan / Taiwan

D Cian Shin Industrial Co., LTD  
 4F, No.101, Ln. 125, Xinchun St.,  
 Tamsui Dist.,  
 New Taipei City 251026 Taiwan (R.O.C.)  
 Tel.: +886 2 26230681  
 Fax: +886 2 26231920  
 E-Mail: sales@cianshin.com.tw

#### Thailand / Thailand

D ST Global Industries Co., Ltd.  
 36 Moo 4, Tambon Pimpha  
 Amphur Bangpakong  
 Chachoengsao, 24130  
 Thailand  
 Tel.: +66 38 595983  
 Fax: +66 38 595363  
 E-Mail: stglobal@st-global.co.th

#### Tschechische Republik / Czech Republic

D CODICO GmbH (via Partner)  
 Zwingenstraße 6-8  
 A-2380 Perchtoldsdorf  
 Tel.: +43 01 86305-0  
 Fax: +43 01 86305-5000  
 E-Mail: office@codico.com

#### Türkei / Türkiye

SD STOCKO CONTACT GmbH & Co. KG  
 Istanbul Liaison Office  
 Atakoy 11. Kisim, Cigdem D Blok, D:33  
 34158 Istanbul / TÜRKIYE  
 Tel.: +90 212 6618710  
 Fax: +90 212 6618720  
 E-Mail: info@stockotr.com

#### Ungarn / Hungary

D CZINEGE Es FIAI Kft.  
 Pesti ucta 36,  
 H-5100 - Jászberény  
 Tel.: +36 057 500190  
 Fax: +36 057 500191  
 E-Mail: czinege@czinege.hu

#### USA / USA

SD STOCKO CONTACT GmbH & Co. KG  
 Sales Office Michigan  
 Detroit  
 Tel.: +1 248 5719596  
 E-Mail: usa@stocko-contact.com

SD STOCKO CONTACT GmbH & Co. KG  
 Sales Office Kentucky  
 Morehead  
 Tel.: +1 606 356 3499  
 E-Mail: usa@stocko-contact.com

SD STOCKO CONTACT GmbH & Co. KG  
 Sales Office Texas  
 El Paso  
 Tel.: +1 915 309 5363  
 E-Mail: usa@stocko-contact.com

D Sensible Micro Corporation  
 13520 Prestige Place  
 Tampa, FL 33635, USA  
 Tel.: +1 877 9921930  
 E-Mail: sales@sensiblemicro.com

#### Vietnam / Vietnam

D C.T.S. Industries (Indochina) Co., Ltd  
 (Ho Chi Minh Branch Office)  
 5th Floor, Mekong Tower,  
 235 - 241 Cong Hoa Street.,  
 Tan Binh District,  
 Ho Chi Minh City, Vietnam  
 Tel.: +84 8 3600 0826  
 Fax: +84 8 6281 6568  
 E-Mail: sales@ctsindochina.com.vn

#### Weißrussland / Belarus

D FEK Company  
 Pushkina 29-B  
 220016 MINSK  
 Belarus  
 Tel.: +375 17 2102189  
 Fax: +375 17 2102189  
 E-Mail: info@fek.lt

**STOCKO CONTACT**  
**GmbH & Co. KG**

Simonshöfchen 31  
D-42327 Wuppertal

Tel. +49 202 9733 - 2  
Fax +49 202 9733 - 411

E-Mail [info@stocko-contact.com](mailto:info@stocko-contact.com)  
Internet [www.stocko-contact.com](http://www.stocko-contact.com)

Ein Unternehmen der Wieland Gruppe  
A Member of the Wieland Group

